

hameco

USB Headset

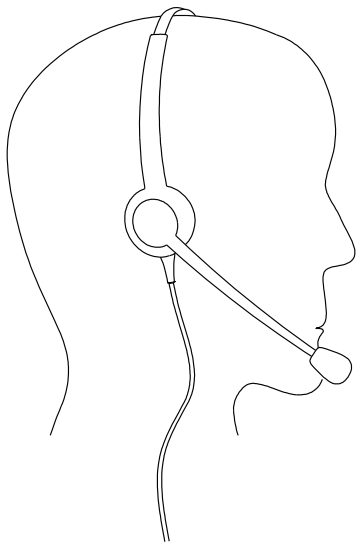
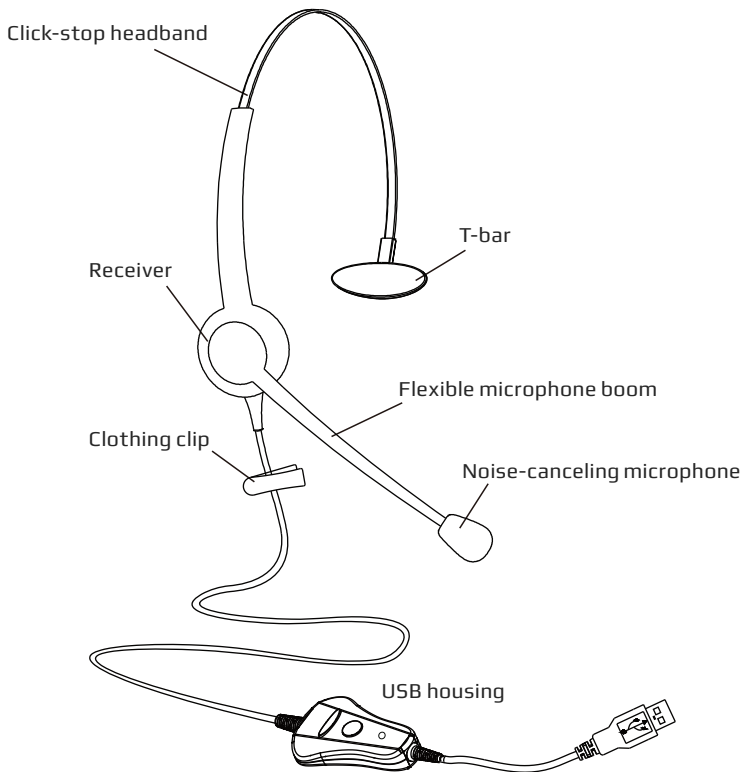

User Manual

HEADSET FEATURES**HS-1000M-USB/HS-1000D-USB**

NEW FEATURE

- Work with any PC & Softphone (Avaya, Cisco system, 3CX)

CONNECTION

- Connect your hameco headset to a free USB port on your PC.
- Make sure that the headset has been selected as the standard audio device in the system control audio setting.
- Check your operating instructions on your softphone application to see if there is a need to adjust the audio setting to use a headset.

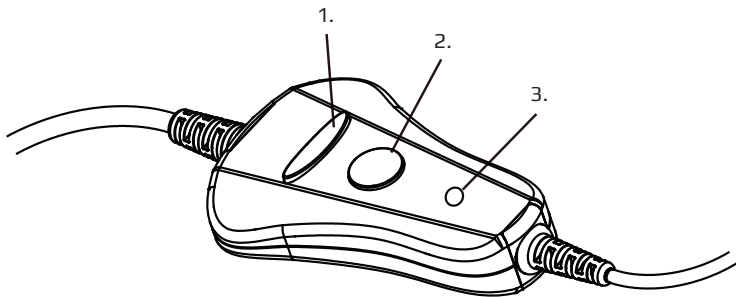

HEADSET COMPONENTS

1. Volume control
2. Mute microphone
3. Display for power and mute

HEADSET FEATURES

HS-2000M-USB/HS-2000D-USB

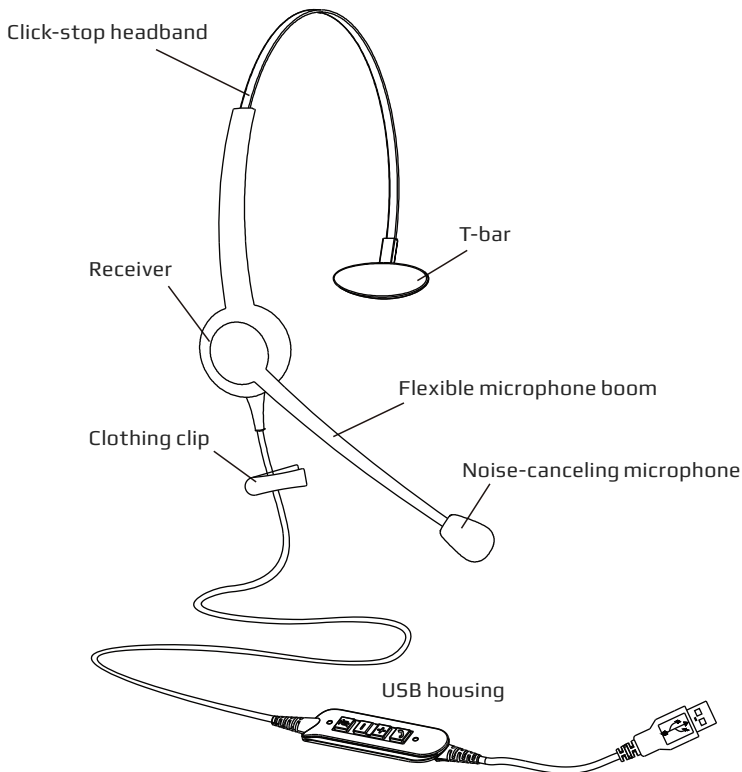

NEW FEATURE

- Work with any PC & Softphone (Skype For Business, Microsoft Lync, Avaya, Cisco system, 3CX)

CONNECTION

- Connect your hameco headset to a free USB port on your PC.
- Make sure that the headset has been selected as the standard audio device in the system control audio setting.
- Check your operating instructions on your softphone application to see if there is a need to adjust the audio setting to use a headset.

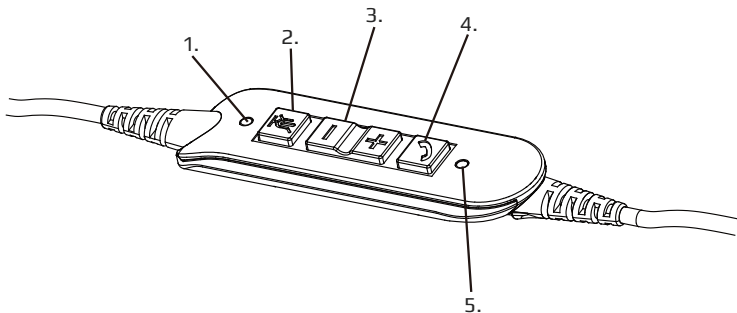

HEADSET COMPONENTS

1. Display for mute microphone
2. Mute microphone
3. Volume control
4. Hook On/Off key
5. Display for Hook Off

HEADSET FEATURES

HS-3500M-USB/HS-3500D-USB

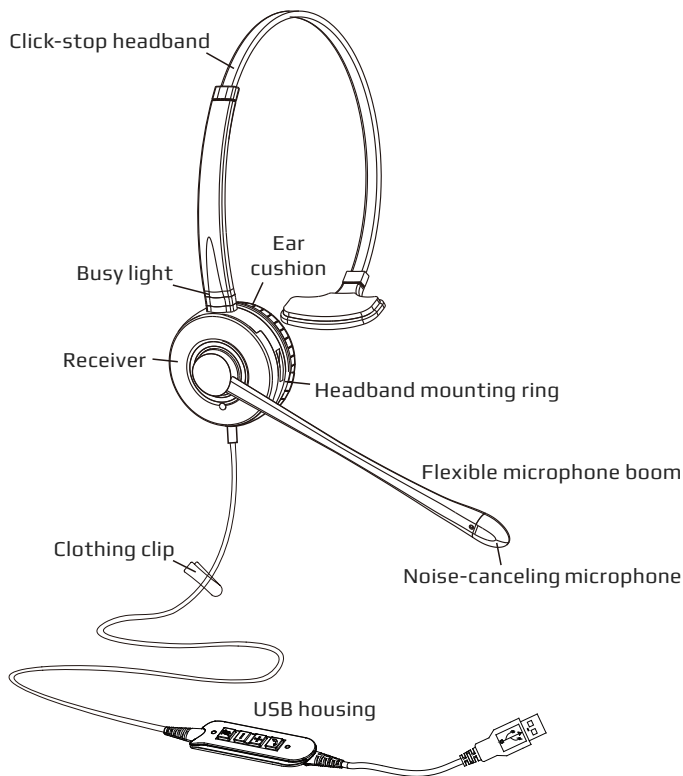

NEW FEATURE

- Work with any PC & Softphone (Skype For Business, Microsoft Lync, Avaya, Cisco system, 3CX)

CONNECTION

- Connect your hameco headset to a free USB port on your PC.
- Make sure that the headset has been selected as the standard audio device in the system control audio setting.
- Check your operating instructions on your softphone application to see if there is a need to adjust the audio setting to use a headset.

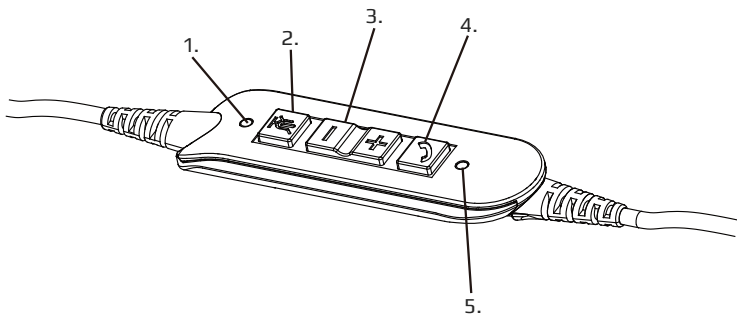

HEADSET COMPONENTS

1. Display for mute microphone
2. Mute microphone
3. Volume control
4. Hook On/Off key
5. Display for Hook Off

CONNECTING YOUR HEADSET

Connect your hameco headset to a free USB port on your PC.



WEARING YOUR HEADSET

To select the listening ear, rotate the microphone boom over the headband to accommodate the left or right ear.

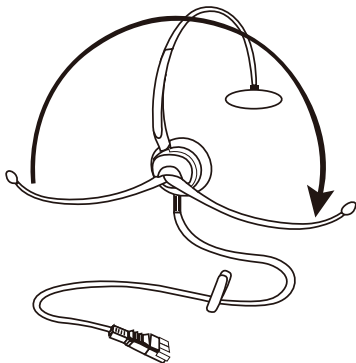



Place the headset receiver to your ear(s). If using a single ear headset, you should set the T-bar above the non-listening ear. Adjust the headband until it is comfortable and ensure that there is no pressure felt on the listening ear(s).

To avoid low or distorted sound and to provide clear and crisp telephone calls, the microphone should be positioned within 30-40 mm of your mouth. The microphone boom arm will move in a variety of directions to ensure the best fit.

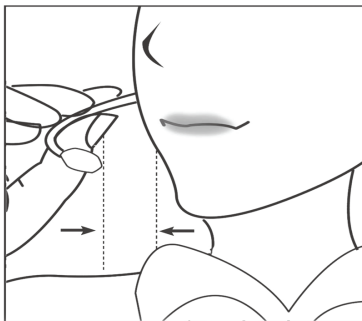
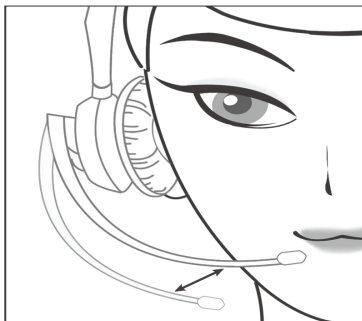



Your new headset is supplied with a clothing clip to allow comfortable fitting of your headset without the cable getting caught or inadvertently pulled. The clothing clip should be fastened at a comfortable level and ensure that there is sufficient slack on the cable to allow free movement of your head without disturbing the headset position.

EAR CUSHION REMOVAL

Using both thumbs to remove the ear cushion by gently prying the earplate away from the groove on the receiver.

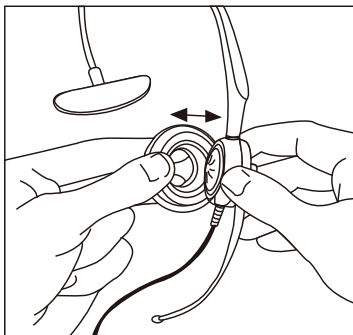

MAINTENANCE

The ear cushions can be removed for cleaning or replacement.

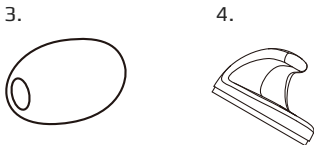
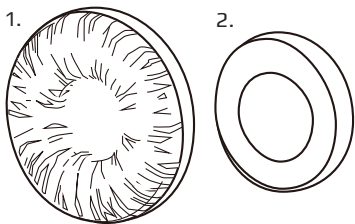
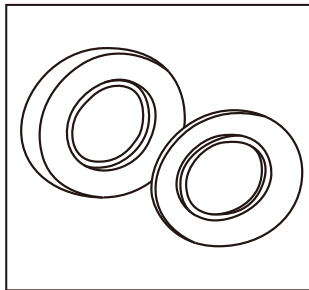
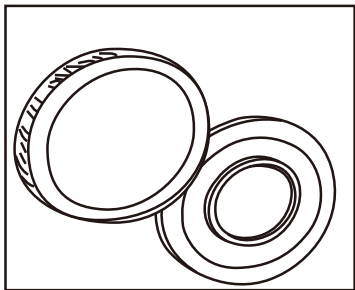

ACCESSORIES (OPTIONAL)

Replacements & enhancements for the headset Series headsets:

1. Leatherette ear cushion;
2. Foam ear cushion;
3. Foam microphone cover;
4. Headset hook;

SAFETY

For your own safety, this product should only be used with CE and RoHS approved equipment. Using this headset with non-approved equipment would void the warranty of this product.

DISPOSAL OF YOUR PRODUCT

Municipal waste stream. Old appliances must be collected separately in order to optimise the recovery and recycling of the materials to reduce the impact on human health and the environment. The crossed out “wheeled bin” symbol on the product reminds you of your obligation that when you dispose of the appliance, it must be separately collected. Consumers should contact their local authority or retailer for information concerning the correct disposal of their old appliance.

