

ATTENTION

Electric Safety

Installation and operation must be in accordance with electrical safety standards.

Transportation

Avoid stress, vibration and immersion in water during transportation, storage and installation.

Polarity of power supply

The power supply of the product is $\pm 12V$, the max electrical current is 2A polarity of the power supply in the drawing below.



Take care when installing

Never move the camera by seizing the camera head. Don't rotate camera head by hand; otherwise mechanical failure may occur. This series item should be put on a smooth desk or platform, and it can not be installed in an oblique position; If the camera is installed on a TV or computer computer, the base can be fixed by four double-sided adhesive trays. Housing of this product is made of organic materials. Do not expose it to any liquid, gas or solids which may corrode the shell. Please ensure that there are no obstacles within the rotation range. Never power on before installation is completed.

Do not disassemble device

We are not responsible for any unauthorized modification or dismantling.

Attention

Electromagnetic field within a certain rate may affect camera image!

1. Fast Installation.....	5
1.1 Camera Interface Explanation.....	5
1.2 Power-on Initial Configuration.....	8
1.3 Video Output.....	8
2. Product Overview.....	11
2.1 Product Introduction.....	11
2.1.1 Product Model.....	11
2.1.2 Dimension.....	12
2.1.3 Accessory.....	12
2.2 Main Features.....	12
2.2.1 Camera Performance.....	12
2.2.2 Network Performance.....	13
2.3 Technical Specification.....	13
2.4 Interface Instruction.....	15
2.4.1 External Interface.....	15
2.4.2 Bottom Dial Switch.....	17
2.4.3 RS-232 interface.....	18
3. Application Instruction.....	20
3.1 Video Output.....	20
3.1.1 Power-On Initial Configuration.....	20
3.1.2 Video Output.....	20
3.2 Remote Controller.....	21
3.2.1 Keys Introduction	
3.2.2 Applications.....	21
3.3 Menu Setting.....	23
3.3.1 Main menu.....	23
3.3.2 System setting.....	24
3.3.3 Camera setting.....	24
3.3.4 P/T/Z.....	27
3.3.5 Video Format.....	28
3.3.6 Version.....	28
3.3.7 Restore Default.....	29
4. Network Connection.....	29
4.1 Connecting Mode.....	29
4.2 IE Log In.....	32
4.2.1 Web Client.....	32
4.2.2 Preview.....	32
4.2.3 Playback.....	32
4.2.4 Configuration.....	33
4.2.5 Video Configuration.....	34

4.2.6 Network Configuration.....	37
4.2.7 System Configuration.....	38
4.2.8 Logout.....	39
4.2.9 Wireless Network.....	40
5. Serial Communication Control.....	40
5.1 VISCA Protocol List.....	40
5.1.1 Camera Return Command.....	40
5.1.2 Camera Control Command.....	41
5.1.3 Inquiry Command.....	46
5.2 Pelco-D Protocol Command List.....	49
5.3 Pelco-P Protocol Command List.....	50
6. Camera Maintenance and Troubleshooting.....	51
6.1 Camera Maintenance.....	51
6.2 Troubleshooting.....	51
Product Disposal.....	52

1. FAST INSTALLATION

1.1 Camera Interface Explanation

Figure 1.1 Interface of ST (standard) Series

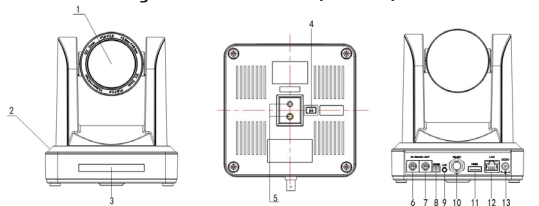

- | | |
|-------------------------------------|-------------------------------------|
| 1. Camera Lens | 8. R5485 Input (left +,right-) |
| 2. Camera Base | 9. Audio Input Interface |
| 3. Remote Controller Receiver Light | 10. 3G-SDI interface |
| 4. Bottom Dial Switch | 11. HDMI Interface |
| 5. Tripod Screw Hole | 12. 10/100M Network Interface |
| 6. R5232 Control Interface (input) | 13. DC12V Input Power Supply Socket |
| 7. R5232 Control Interface (output) | |

Figure 1.2 Interface of U3 (USB3.0) Series

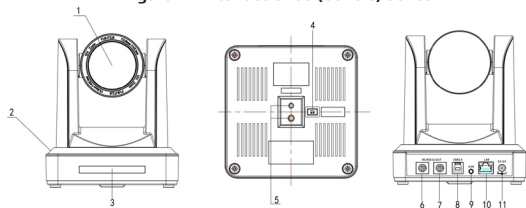

- | | |
|-------------------------------------|-------------------------------------|
| 1. Camera Lens | 7. R5232 Control Interface (output) |
| 2. Camera Base | 8. USB3.0 interface |
| 3. Remote Controller Receiver Light | 9. Audio Input Interface |
| 4. Bottom Dial Switch | 10. 10/100M Network Interface |
| 5. Tripod Screw Hole | 11. DC12V Input Power Supply Socket |
| 6. R5232 Control Interface (input) | |

Figure 1.3 Interface of U2 (USB2.0) Series

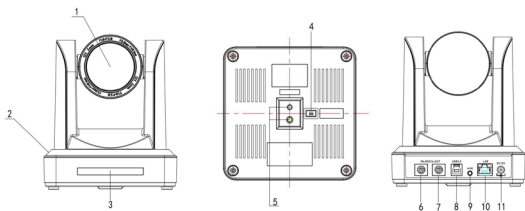

- | | |
|-------------------------------------|-------------------------------------|
| 1. Camera Lens | 7. RS232 Control Interface (output) |
| 2. Camera Base | 8. USB2.0 interface |
| 3. Remote Controller Receiver Light | 9. Audio Input Interface |
| 4. Bottom Dial Switch | 10. 10/100M Network Interface |
| 5. Tripod Screw Hole | 11. DC12V Input Power Supply Socket |
| 6. RS232 Control Interface (input) | |

Figure 1.4 Interface of HD BaseT Series

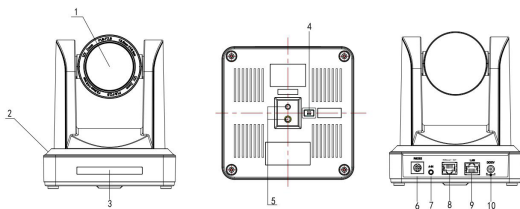

- | | |
|-------------------------------------|------------------|
| 1. Camera Lens | 6. RS232(IN) |
| 2. Camera Base | 7. Audio-in |
| 3. Remote Controller Receiver Light | 8. HDBaseT |
| 4. Tripod Screw Hole | 9. Lan |
| 5. Bottom Dial Switch | 10. Power Supply |

1.5 HM Model(HDMI Output)

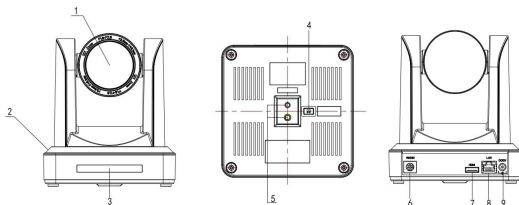

1. Camera Lens
2. Camera Base
3. Remote Controller Receiver Light
4. Tripod Screw Hole
5. Bottom Dial Switch

6. R5232(IN)
7. HDMI Output
8. Lan
9. Power Supply

1.6 U2U3 (USB2.0, USB3.0, HDMI Output)

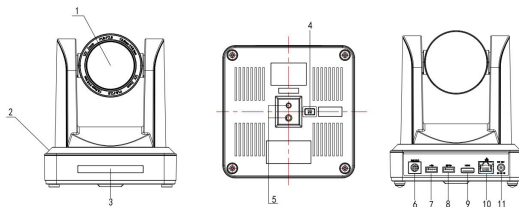

1. Camera Lens
2. Camera Base
3. Remote Controller Receiver Light
4. Bottom Dial Switch
5. Tripod Screw Hole
6. R5232(IN)

7. USB 2.0
8. USB 3.0
9. HDMI Output
10. LAN
11. Power Supply

Note: ST model is standard interface, U3 model is USB3.0 interface, U2 model has USB2.0 interface, HD model has HD BaseT interface. Users should read the manual according to the specific model.

1.2 Power on initial configuration

1) Power on: Connect DC12V power supply adapter with power supply socket.

2) Initial configuration: Power on with power indicator light on and remote control receiver light blinking, camera head moves from bottom left to the bottom, and then goes to the HOME position (intermediate position of both horizontal and vertical), while the camera module stretches. When remote control receiver light stops blinking, the self-check is complete.

Note: If you set preset 0, when the Power on self-test is completed, the camera automatically moves to the preset 0 position.

1.3 Video Output

This series has a variety of video outputs; ST models have video output from LAN, HDMI and 3G-SDI, U3 models from LAN and USB3.0 which are compatible with USB2.0, and U2 models from LAN and USB2.0. HD models from LAN and HD-BaseT, HM Models from HDMI and Lan; U2U3 models from LAN/USB2.0/USB3.0/HDMI ports.

1) Video Output from LAN

a. Network Cable Connection Port: ST Model--No.12 in Figure1.1; U3 Model--No. 8 in Figure1.2; U2 Model--No.8 in Figure 1.3.HD Model--No.9 in Figure1.5; U2U3 Model --No.10 in Figure1.6.

b. Webpage Login: Open your browser and enter 192.168.5.163 in the address bar (factory default); press Enter to enter into the login page; click on the "player is not installed, please download and install!" and follow the installation steps for installation.

Then enter the user name admin and password admin (factory default); press Enter to enter into the preview page, users can carry out PTZ control, video recording, playback, configuration and other operations.

2) HDMI Video Output

a. HDMI Video Cable Connection: ST models refer to No.11 in Figure1.1. U2U3 models refer to No.9 in Figure1.6.

b. Connect the camera and the monitor via HDMI video cable; video output is available after camera self-test.

3) 3G-SDI Video Output

a. 3G-SDI video cable connection: ST models refer to No.10 in Figure1.1.

b. Connect the camera and the monitor via 3G-SDI video cable; video output is available after camera self-test.

4) USB3.0 video output

a. USB3.0 video cable connection: U3 models refer to No.7 in figure1.2.U2U3 models refer to No.8 in Figure1.6.

b. Connect the camera and the monitor via USB3.0 video cable, open video display software, select image device, and then video output will be available.

5) USB3.0 compatible with USB2.0 output

a. USB3.0 video cable connection: U3 models refer to No.7 in Figure1. 2.U2U3 models refer to No.8 in Figure1.6.

b. Connect the camera and the monitor via USB3.0 video cable, open video display software, select image device, and then video output will be available.

6) USB2.0 video output

a. USB2.0 video cable connection: U2 models refer to No.7 in Figure1. 3.U2U3 models refer to No.7 in Figure1.6.

b. Connect the camera and the monitor via USB2.0 video cable, open video display software, select image device, and then video output will be available.

7) HDBaseT video output

a. IP cable connect: HD model please refer to figure 1.0 No.8.

b. Connect the device, HD BaseT signal receiving device and the display together properly through the network cable and video cable. Image will be displayed after the device fhas finished.

HD BaseT signal receiving device : HD BaseT adapter box, input HD BaseT signal, output HDMI signal.

Note: USB2.0 output and USB3.0 output is the same interface.

1.4 Bracket mount

Note: Bracket can only be wall mounted or mounted upside-down on a template and concrete wall, but cannot be installed on plasterboard.

www

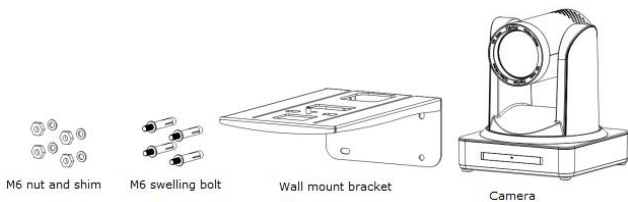

Finish

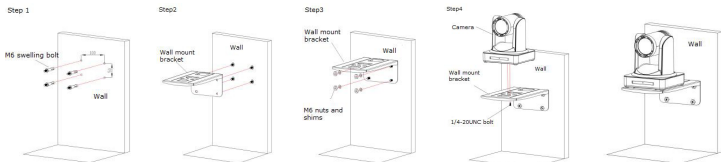

2. Upside-down mount step

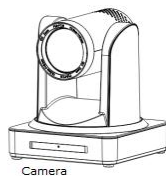
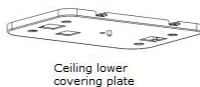

Step1

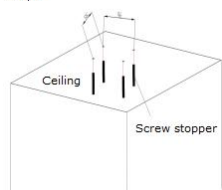

Step2

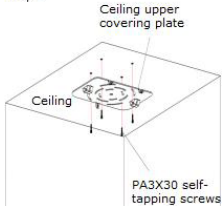

Step3

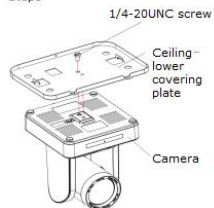

Step4

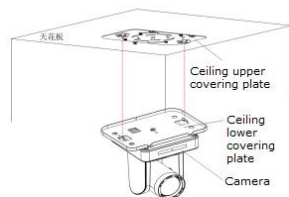

Step5

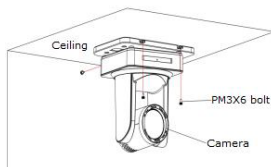

2. PRODUCT OVERVIEW

2.1.1 Product Model

There are four main series according to different video formats, lens optical zooms, output interfaces and remote control modes.

HV-51

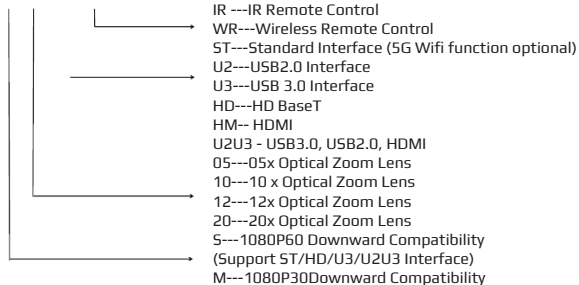

Please refer to the corresponding features in this manual.

Note: 5Gwifi is optional for ST (standard) series only.

2.1.2 Dimension

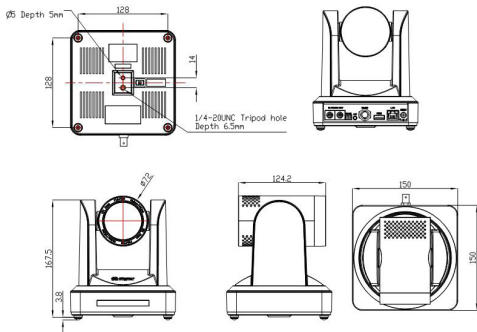

2.1.3 Accessories

Please refer to the corresponding features in this manual.

Model NO.	Configuration	ST/HD/HM Series	U3 Series	U2 Series	U2U3 Series
Accessories	Standard	Power adapter 1piece			
		R5232 cable 1 piece	USB3.0 cable 1 piece	USB2.0 cable 1 piece	USB3.0 and USB2.0 cables
		User manual 1			
		Double-side glue shim 4pcs			
		Warranty card 1 piece			
	Optional	IR Remote control piece	IR Remote control or wireless controller piece		
		Wireless controller 1 piece			
		Wall mounting bracket (optional)			
		Upside-down mounting bracket (optional)			
		Cascade cable			

USB2.0 Video cable: If a USB2.0 cable is needed to provide power but not a power adapter, USB2.0 Video cable with two ports is needed, the red port is for power supply and black port for transmitting USB video signals. If using a power adapter, the general USB2.0 video cable without power supply function is fine.

2.2 Main Features

2.2.1 Camera Performance

This series camera offers perfect functions, superior performance and rich interfaces. The features include advanced ISP processing algorithms to provide vivid images with a strong sense of depth, high resolution and fantastic color rendition. It supports H.265/H.264 encoding which makes motion video fluent and clear even with less than ideal bandwidth conditions.

1. Superb High-definition Image: It employs 1/2.8 inch high quality CMOS sensor. Resolution is up to 1920x1080 with frame rate up to 60 fps.

2. Various Optical Zoom Lens: It has 5X/10X/12X/20X optical zoom lens for options. The 5X zoom lens has a 80.9 ° wide view angle without distortion.

3. Leading Auto Focus Technology: Leading auto focus algorithm makes the lens fast, accurate and provides stable auto-focusing.

4. Low Noise and High SNR: Low Noise CMOS effectively ensure high SNR of camera video. Advanced 2D/3D noise reduction technology is also used to further reduce the noise, while ensuring image sharpness.

5. Quiet PTZ: By adopting a high accuracy step driving motor mechanism, it works extremely quietly and moves smoothly and quickly to the designated position.

6. Multi-Format Video Outputs: supports HDMI, 3G-SDI, USB, wired LAN and wireless LAN interfaces. The 3G-SDI is available for 100m transmission at 1080p60 format.

7. Multiple Remote Controls: There is an IR remote and 2.4G wireless remote for options. The 2.4G wireless remote controller will not be affected by angle, distance or IR interference. Supports transparent transmission functions.

8. Low-power Sleep Function: Supports low-power sleep/wake up, the consumption is lower than 500mW under sleep mode

9. Support Multiple Control Protocol: Supports VISCA, PELCO-D, PELCO-P protocols which can also be automatically recognized. Supports VISCA control protocol through IP port.

10. RS-232 Cascade Function: ST series supports RS-232 cascade function which is convenient for installing.

11. 255 Presets Positions: Up to 255 presets (10 presets with remote).

12. Wide Application: Tele-education, capturing lectures, webcasting, video-conferencing, tele-training, tele-medicine, interrogation and emergency command systems.

2.2.2 Network performance

1. Audio Input Interface: Supports 16000,32000,44100,48000 sampling frequency and AAC, MP3, PCM audio coding.

2. Multiple Audio/Video Compression: Supports H.264/H.265 video compression; AAC,MP3 and PCM audio compression; Supports compression of resolution up to 1920x1080 with frame up to 60 fps and 2 channel 1920x1080p with 30 fps compression.

3. Multiple network protocols : Supports ONVIF,RTSP,RTMP protocols and RTMP push modes, easy to link streaming media server (Wowza, FMS)

4. 5G WIFI function: If the product contains a 5G wifi module, you can set up a wireless wifi connection in a webpage, the specific configuration is described in detail on the page on web configuration.

2.3 Technical Specifications

Model	5X	10X	15X	20x
Camera Parameter				
Sensor	1/2.8 inch high quality HD CMOS sensor			
Effective Pixels	16: 9 2.07 megapixel			
Video Format	HDMI/SDI/HDBaseT video format 1080P60/50/30/25/59.94/29.97;1080I60/50/59.94;720P60/50/30/25/59.94/29.97 U3 interface video format 1)U3:1920X1080P60/50/30/25;1280X720P60/50/30/25;960X540P30;640X-360P30;640X480P30;352X288P30;960X540P30; 2)U3 compatible with U2: 960X540P30; 640X360P30; 1280X720P10/15; 720X576P50; 720X480P60; 640X480P30; 352X288P30. U2 interface video format 176x144/320x240/320x180/352x288/640x480/720x576/640x360/800X600/960X-540/1024X576/1024X768/1600X896/1920X1080/1280X720 P30/25/20/15/10/5			
Optical Zoom	5X f 3.6 18mm	10X f 4.7 47mm	12X f 3.9 46.1mm	20X f 5.2 98mm
View Angle	16.43° tele 80.9° wide	6.43° tele 60.9° wide	6.3° tele 72.5° wide	3.2° tele 55.8° wide

Model	5X	10X	15X	20x
Camera Parameter				
AV	F1.6 – F3.0	F1.6 – F3.0	F1.8 – F2.4	F1.5 – F3.0
Digital Zoom	10X			
Minimum Illumination	0.5Lux (F1.8, AGC ON)			
DNR	2D & 3D DNR White Balance Auto / Manual/ One Push/ 3000K/			
White Balance	Auto / Manual/ One Push/ 3000K/ 4000K/5000K/6500K			
Focus	Auto/Manual			
Aperture	Auto/Manual			
Electronic Shutter	Auto/Manual			
BLC	ON/OFF			
WDR	OFF/ Dynamic level adjustment			
Video adjustment	Brightness, Color, Saturation, Contrast, Sharpness, B/W mode, Gamma curve			
SNR	>55dB			

Input/Output Interface	
Video Interfaces	UV510A-05/10/12/20-ST Model HDMI, 3G-SDI, LAN, Audio-in UV510A-05/10/12/20-U2 Model USB2.0(power supply available) LAN, Audio-in UV510A-05/10/12/20-U3 Model USB3.0(power supply available)LAN, Audio-in UV510A-05/10/12/20-HD Model HDBaseT(POE), LAN, Audio-in UV510A-05/10/12/20-HD Model HDMI, LAN, RS232(in) UV510A-05/10/12/20-U2U3 Model USB2.0, USB3.0, HDMI, LAN, RS232 input
Image code stream	Double streams outputs simultaneously
Video format Compression	H.264, H.265
Control Signal Interface	RS-232 Ring through RS232 output, RS-485
Control Protocol	VISCA/Pelco-D/Pelco-P; Baud Rate: 115200/9600/4800/2400bps
Audio input Interface	Double track 3.5mm linear input;
Audio Compression Format	AAC/MP3/PMC Audio compression
HD IP Interface	100M IP port(100BASE-TX); 5G WiFi (optional), support IP Visca control protocol
Network Protocol	RTSP/RTMP,ONVIF
Power Interface	HEC3800 outlet (DC 12V)

PTZ Parameter	
Pan Rotation	±170°
Tilt Rotation	-30° +90°
Pan Control Speed	0.1 -180°/sec
Tilt Control Speed	0.1-80°/sec
Preset Speed Pan	60°/sec, Tilt: 30°/sec
Preset Number	255 presets (10 presets by remote controller)
Other Parameter	
Supply Adapter	AC110V-AC220V to DC12V/2A
Input Voltage	DC12V±10%
Input Current	1A(Max)
Consumption	12W (Max)
Store Temperature	-10 to +60
Store Humidity	20% - 95%
Working Temperature	-10 to +50
Working Humidity	20%--80%
Dimension	150mmX150mmX167.5mm
Weight	1.4KG
Working Environment	Indoor
Remote Operation	(IP) Remote Upgrade, Reboot and Reset
Accessory	Power Supply, RS232 Control Cable, USB3.0 Cable (U3 Model), USB2.0 Cable (U2 Model), Remoter Manual Warranty card
Optional Accessory	Bracket

2.4 Interface Instructions

2.4.1 External Interface

1) External interface of ST models: RS232 Input /Output, RS485 Input, Audio Input, 3G-SDI Output, HDMI Output, LAN, DC12V Power Interface.

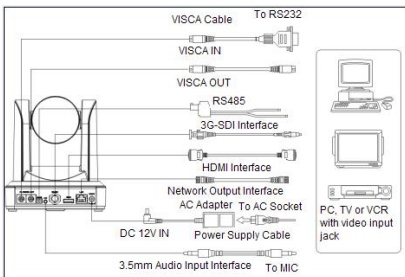

2) External interface of U3 model:

Audio Input, USB 3.0 Output, LAN, DC12V Power Interface.

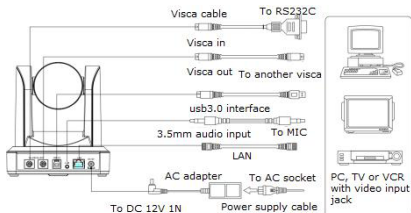

3) External interface of U2 model:

Audio Input, USB 2.0 Output, LAN, DC12V Power Interface.

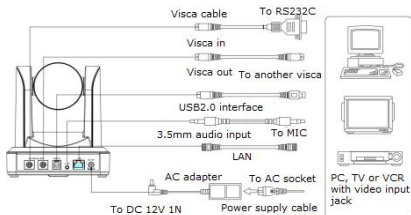

4) External interface of HD model:

Audio Input, HD Baset Output, LAN, DC12V Power Interface.

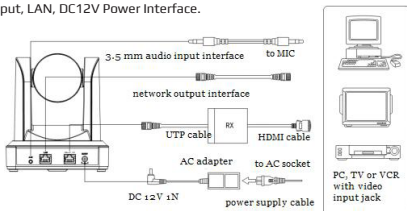
**4) E5) External interface of U2U3 model:**

R5232 input, USB3.0, USB2.0, HDMI, LAN, DC12V power interface.

2.4.2 Bottom Dial Switch

ST model , U3 model and U2 model Bottom Dial Switch diagram shown in Figure 2.6 and 2.7:

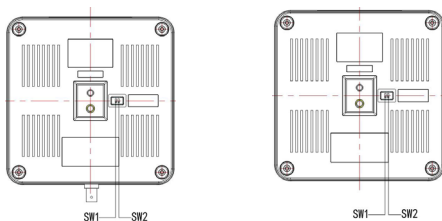

ST/U2/HD model: two DIP switches are set to ON or OFF to select different modes of operation as shown in Table 2.2

No.	SW1	SW2	Explanation
1	OFF	ON	Working mode
2	ON	OFF	Updating mode

ST/U2/HD model: two DIP switches are set to ON or OFF to select different modes of operation as shown in Table 2.2

No.	SW2	SW1	Explanation
1	ON	OFF	Working mode
2	ON	ON	USB3.0 Software Upgrade Mode
3	OFF	ON	ARM Software Upgrade Mode

Note: Working mode can be applicable for web upgrade.

2.4.3 RS-232 Interface

1) ST model RS-232C interface specification as shown below

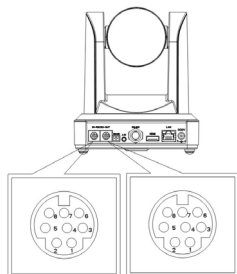

Computer or keyboard and camera connection method

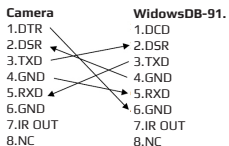

2) RS-232 Mini-DIN 8-pin Port Definition

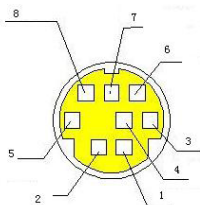

No.	Port	Definition
1	DTR	Data Terminal Ready
2	DSR	Data Set Ready
3	TXD	Transmit Data
4	GND	System Ground
5	RXD	Receive Data
6	GND	System Ground
7	IR OUT	IR Commander Signal
8	NC	No Connection

3) RS232 (DB9) Port Definition

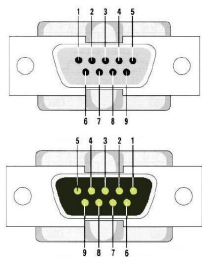

No.	Port	Definition
1	DCD	Data Carrier Detect
2	RXD	Receive Data
3	TXD	Transmit Data
4	DTR	Data Terminal Ready
5	GND	System Ground
6	DSR	Data Set Ready
7	RTS	Request to Send
8	CTS	Clear to Send
9	RI	Ring Indicator

4) VISCA networking as shown below:

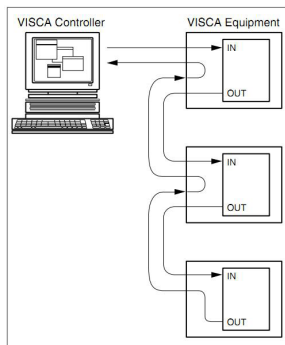

Camera cascade connection method

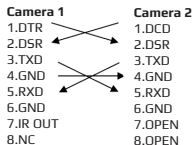

Note: ST model has RS232 input and output interface, so you can cascade as above. It won't work for the U3 model since the U3 model only has an RS232 input interface.

3. APPLICATION INSTRUCTIONS

3.1 Video Output

3.1.1 Power-On Initial Configuration

Connecting the power, camera will start initial configuration the R indicator light will be flashing. When the camera returns to the HOME position (middle position for P/T), and lens finishes zooming in/out, the auto-testing is complete. IR LED will also stop flashing. If the preset 0 is set, camera will rotate to the 0 preset position after initial configuration.

3.1.2 Video Output

Connect to the video output cable: the user selects the output mode according to the machine model. Figure 1.4.1 is for your reference (output interface introduction for each product)

1) network output: connect this product and your computer through the network cable then open the browser, enter the camera IP address (factory default 192.168.5.163) in the address bar, in the login page input a user name and password (factory default are "admin") . Finally, enter the preview page, and the image comes out.

(Note: If you forget your user name, password, IP address, you can manually restore the default with the remote control key combination * #)

2)3G-SDI output or DVI (HDMI) output: Connect the monitor with the corresponding video output interface, then the monitor will output the image.

3)USB3.0 output: Connect this product with computer USB3.0 interface (blue), open the Device Manager to see whether there is an image device and whether the Universal Serial Bus controllers recognize USB3.0 device. After being properly identified, open the software, choose the image device and then it will output the image.

4)USB3.0 compatible with USB2.0 output: Connect this product with computer USB2.0 interface (black), open the Device Manager to see whether there is an image device and whether the Universal Serial Bus controllers recognize USB3.0 device. After proper identification, open the software, choose the image device and then it will output the image.

3.1 Remote Control

3.2.1 Key Instructions



1. Standby Key

After pressing for 3 seconds, the camera will step into standby mode. Press for 3 seconds again, the camera will self-test again and go back to HOME position.
(Note: If power-on mode is turned on and Preset 0 is set, and there is no operation within 12s, it will automatically point to the specified preset position.)

2. Camera Address Selection

Select the camera address that you want to control.

3. Number Key

Set or run 0-9 presets

4. *,# Key

Key combination use

5. Focus Control Key

Auto Focus: Enter into auto focus mode.

Manual Focus: The camera focus mode is manual

Switch the camera focus mode to manual focus by pressing [focus +] or [focus -] to adjust.

6. Zoom Control Key

Zoom :Lens near

Zoom :Lens far

7. Set or Clear Preset key

Set Preset: Set preset key + 0-9 number key;

Clear Preset key: Clear preset key + 0-9 number key

8. Pan/Tilt Control Key

Press ▲ Key :Up

Press ▼ Key :Down

Press ◀ Key :Left

Press ▶ Key :Right

“HOME” Key: Return to the middle position or enter into the next level menu

9. BLC Control Key

Back Light ON / OFF: Turn on or off the back light

10. Menu Setting

Open or close the OSD menu

Enter / exit the OSD menu or return to the previous menu.

11. Camera IR Remote Control Address Setting

* + + F1 :Camera Address No.1

* + + F2 :Camera Address No. 2

* + + F3 :Camera Address No. 3

* + + F4 :Camera Address No. 4

12. Key Combination Functions

1) # + # + # :Clear all presets

3) * + # + 9 :Flip switch

5) * + # + 3 :Menu set to Chinese

7) * + # + Manual: Restore the default user name, password, and IP address

9) # + # + 1 :Switch the video format to 1080P50

11) # + # + 3 :Switch the video format to 1080I50

13) # + # + 5 :Switch the video format to 720P50

15) # + # + 7 :Switch the video format to 1080P25

17) # + # + 9 :Switch the video format to 720P25

2) * + # + 6 :Restore factory defaults

4) * + # + Auto: Enter into the aging mode

6) * + # + 4 :Menu set to English

8) # + # + 0 :Switch the video format to 1080P60

10) # + # + 2 :Switch the video format to 1080I60

12) # + # + 4 :Switch the video format to 720P60

14) # + # + 6 :Switch the video format to 1080P30

16) # + # + 8 :Switch the video format to 720P30

3.2.2 Applications

Finishing initialization, it can receive and execute the IR commands. Press the remote controller button, the indicator light is flashing; release the button, the indicator light stops flashing. Users can control the pan/tilt/zoom, setting and running preset positions via the IR remote controller.

Key Instruction:

1. In this instruction, "press the key" means a click rather than a long-press, and a special note will be given if a long-press for more than one second is required.
2. When a key-combination is required, do it in sequence. For example, " * + # + F1 " means press " * " first and then press " # " and last press " F1 ".

1) Camera Selection

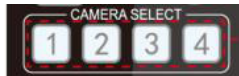

Select the camera address to control.

2) Pan/Tilt Control



Up: press ▲ **Down:** press ▼
Left: press ◀ **Right:** press ▶
Back to middle position: press " HOME "

Press and hold the up/down/left/right key, the pan/tilt will keep running, from slow to fast, until it runs to the endpoint; the pan/tilt running stops as soon as the key is released.

3) Zoom Control

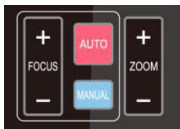

ZOOM IN: press "ZOOM " ▲ key

ZOOM OUT: press "ZOOM " ▼ key

Press and hold the key, the camera will keep zooming in or zooming out and stops as soon as the key is released.

4) Focus Control



Focus (near): Press " focus+ " key (Valid only in manual focus mode)

Focus (far): Press " focus- " key (Valid only in manual focus mode)

Auto Focus: Support

Manual Focus: Support

Press and hold the key, the action of focus will keep continue and stops as soon as the key is released.

5) BLC Setting



BLC ON / OFF: support

6) Presets Setting, Running, Clearing



1. Preset setting: to set a preset position, the users should press the " SET PRESET " key first and then press the number key 0-9 to set a relative preset.

Note: 10 preset positions in total are available by remote control.

2. Running a Preset: Press a number key 0-9 directly to run a relative preset.

Note: Action is in vain if there is no relative preset position.

3. Preset clearing : to clear a preset position, the user can press the " CLEAR PRESET " key first and then press the number key 0-9 to clear the relative preset;

Note : press the " # " key three times continually to cancel all the presets.

7) Camera Remote Controller Address Setting



* + F1 :Camera Address No.1

* + F2 :Camera Address No. 2

* + F3 :Camera Address No. 3

* + F4 :Camera Address No. 4

3.3 MENU SETTING

3.3.1 Main Menu

In normal working mode, press MENU key to display the menu, using scroll arrow to point at or highlight the selected items.

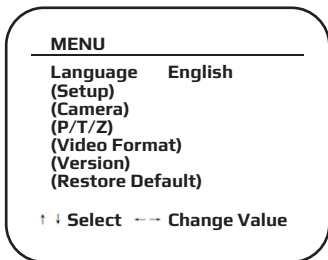

LANGUAGE: Language setting, Chinese / English

SETUP: System setting

CAMERA OPTION: Camera setting

PTZ OPTION: Pan tilt setting

VERSION: camera version setting

Restore Default: Reset setting

[↑ ↓] Select: for selecting menu

[← →] Change Value: for modifying parameters

[MENU] Back: Press [MENU] to return

[Home] OK: Press [Home] to confirm

3.3.2 System Setting

Move the pointer to the (Setup) in the Main Menu, click the HOME key and enter into the (System Setting) as shown below.

SETUP	
Protocol	Auto
Visca Address	1
Visca Address Fix	OFF
PELCO-P Address	1
PELCO-D Address	0
Baudrate	9600
↑ ↓ Select -- Change Value Value	

PROTOCOL: VISCA/Pelco-P/Pelco-D/Auto
Visca ADDR: VISCA=1~7 Pelco-P=1~255 Pelco-D = 1~255
Baud rate: 2400/4800/9600/115200
Visca Address Fix: On/Off

3.3.3 Camera Setting

Move the pointer to the (CAMERA) in the Main Menu, click the HOME key and enter the (CAMERA) as follows.

CAMERA	
(Exposure)	
(Color)	
(Image)	
(Focus)	
(Noise Reduction)	
↑ ↓ Select -- Change Value Value	

EXPOSURE: Enter into Exposure setting
COLOR: Enter into color setting
Image: Enter into image setting
Focus: Enter into focus setting
Noise Reduction: Enter into noise reduction

1) EXPOSURE SETTING

Move the pointer to the (EXPOSURE) in the Main Menu, click the **HOME** and enter the (EXPOSURE SET) as follows.

EXPOSURE

MODE	AUTO
EV	OFF
BLC	OFF
ANTI-FLICKER	50HZ
GAIN LIMIT	3
WDR	5

↑ ↓ **Select** -- Change Value
Value

Mode : Auto, Manual, Shutter priority, Iris priority and Brightness priority.

EV : On/Off (only available in auto mode)

Compensation Level: -7~7 (only available in auto mode when EV is ON)

BLC: ON/OFF for options (only available in auto mode)

Anti-Flicker: OFF/50Hz/60Hz for options (only available in Auto/Iris priority/Brightness priority modes)

Gain Limit: 0~15(only available in Auto/ Iris priority /Brightness priority mode)

WDR: Off, 1~8
Shutter

Priority: 1/25, 1/30, 1/50, 1/60, 1/90, 1/100, 1/120, 1/180, 1/250, 1/350, 1/500, 1/1000, 1/2000, 1/3000, 1/4000, 1/6000, 1/10000(only available in Manual and Shutter priority mode)

IRIS Priority:OFF, F11.0, F9.6, F8.0, F6.8, F5.6, F4.8, F4.0, F3.4, F2.8, F2.4, F2.0, F1.8(only available in Manual and Iris priority mode)

Brightness: 0~23 (only available in Brightness priority mode)

2) COLOR SETTING

Move the pointer to the (COLOR) in the Main Menu, click **HOME** and enter the (COLOR SET) as follows.

COLOR

WB MODE	AUTO
SATURATION	80%
HUE	7
AWB Sensitivity	HIGH
COLOR STYLE	DEFAULT
COLOR TEMP	LOW

↑ ↓ **Select** -- Change Value
Value

WB Mode: Auto, 3000K 3500K 4000K 4500K 5000K 5500K 6000 K 6500K 7000K, Manual, One Push

Red Gain: 0~255(only available in Manual mode)

Blue Gain: 0~255(only available in Manual mode)

Saturation: 60%, 70%, 80%, 90%, 100%, 110%, 120%, 130%

Hue: 0~14

AWB Sensitivity: high/middle/low

Color Style: Default, style1~4.

Color Temp: high/middle/low

3) IMAGE

Move the pointer to (IMAGE) in the Menu, click **HOME** and enter (IMAGE) as follows.

IMAGE

BRIGHTNESS	6
CONTRAST	8
SHARPNESS	7
FLIP-H	OFF
FLIP-V	OFF
B&W MODE	COLOR
GAMMA	DEFAULT
DZOOM	OFF
DCI	CLOSE

↑ ↓ Select ← → Change Value
VALUE

Brightness: 0~14
Contrast: 0~14
Sharpness: 0~15
Flip-H: On/Off
Flip-V: On/Off
B&W Mode: color, black/white
Gamma: default, 0.47, 0.50, 0.52, 0.55
DZoom: digital zoom options: On/Off
DCI: Dynamic Contrast: Off, 1~8

4) FOCUS

Move the pointer to (FOCUS) in the Menu, click **HOME** and enter the (FOCUS) as follows.

FOCUS

FOCUS MODE	AUTO
AF-ZONE	CENTER
AF-SENSITIVITY	LOW

↑ ↓ Select ← → Change Value
Value

Focus Mode: Auto, manual
AF-Zone: Up, middle, down
AF-Sensitivity: High, middle, low

5) NOISE REDUCTION

Move the pointer to (NOISE REDUCTION) in the Menu, click **HOME** and enter the (NOISE REDUCTION) as follows.

Move the pointer to (FOCUS) in the Menu, click **HOME** and enter the (FOCUS) as follows.

NOISE REDUCTION

NR-2D	AUTO
NR-3D	3
DYNAMIC HOT PIXEL	OFF

↑ ↓ Select ← → Change Value
Value

2D Noise Reduction: Auto, close, 1~7

3D Noise Reduction: Close, 1~8

Dynamic Hot Pixel: Close, 1~5

3.3.4 P/T/Z

Move the pointer to (P/T/Z) in the Main Menu, click **HOME** and enter the (P/T/Z) as follows.

P/T/Z

DEPTH OF FIELD	ON
ZOOM SPEED	8
IMAGE FREEZING	OFF
ACC CURVE	SLOW

↑ ↓ Select ← → Change Value
Value

Depth of Field: Only effective with remote control, On/ Off; When zoomed in, the PT control speed by remote will become slow),

Zoom Speed: Set the zoom speed for remote control, 1~8

Image Freezing: On/Off

Accelerating Curve: Fast/slow

3.3.5 Video Format

Move the pointer to (Video Format) in the Menu, click the **HOME** and enter (Video Format) as follows.

P/T/Z	
1080P60	1080P50
1080I60	1080I50
1080P30	1080P25
720P60	720P50
720P30	720P25
1080P59.94	1080I59.94
1080P29.97	720P59.94
720P29.97	
↑ ↓	
[Menu]Back]Select

Note:

1. **S:** 1080P60 Downward Compatibility; **M:** 1080P30 Downward Compatibility

2. Exit menu after modifying parameters to save it after powering off

S Version: 1080P60 1080P50 1080P30 1080P25 1080I60 1080I50 720P60 720P50 720P30 720P25 1080P59.94 1080I59.94 1080P29.97 720P59.94 720P29.97 Optional

M Version: 1080P30 1080P25 1080I60 1080I50 720P60 720P50 Optional

3.3.6 Version

Move the pointer to (VERSION) in the Main Menu, click the **HOME** and enter (VERSION) as follows.

VERSION		
MCU VERSION	2.0.0.15	2015-12-188
CAMERA VERSION	2.0.0.13	2015-12-18
AF VERSION	2.0.0.6	2015-12-11
LENS	12X(20X)	
[Menu]Back		

MCU Version: Display MCU version information

Camera Version: Display camera version information

AF Version: Display the focus version information

Lens: Display the lens zoom

3.3.7 Restore Default

Move the pointer to (RESTORE DEFAULT) in the Main Menu, click **HOME** and enter the (RESTORE DEFAULT) as follows.

RESTORE DEFAULT

RESTORE DEFAULT? NO

↑ ↓ Select ← → Change Value
Value

Restore default: options: yes/no; after restoring default, the video format won't be restored.

Note: If the address of former remote is not 1 but another one from 2,3,4, the corresponding camera address will restore to 1 when all parameters or system parameters are restored. User should change the remote address to be 1 (press No.1 according to the camera for normal operation)

4. NETWORK CONNECTION

4.1 Connecting Mode

Direct connection: Connect the camera and computer by network connecting cable.

Internet connection mode: Connect the camera to the Internet by Router or Switch, then the user can log into the device using a browser.

Note: Please do not put the power and network cable in places where can be easily touched to prevent low video quality due to unstable signal transmission.

The computer must have the network segment the camera IP address belongs to. The device will not be accessible without the segment. I.E. if the camera default IP address is 192.168.5.163, then segment 5 must be added in the computer. Specific steps are as below:

First open Local Area Connection Properties on computer, select the "Internet protocol version 4(TCP/IPv4)" as shown on picture on the left. Double click or click the property "Internet" protocol version 4 (TCP/IPv4) to enter into the Internet Protocol Version 4(TCP/IPv4) Properties window, select "Advanced" to enter into the Advanced TCP/IP Setting and add IP and subnet mask in the IP browser as in picture shown below. Click "Confirm" to finish the adding of IP segment. User can add the corresponding network segment according to the revised IP address of the camera.

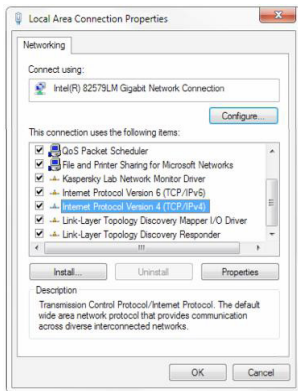

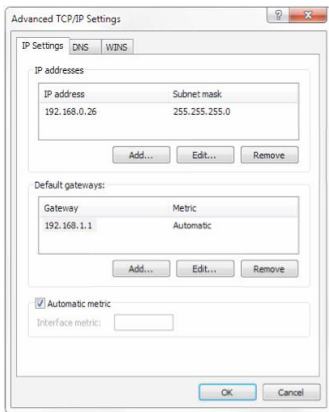
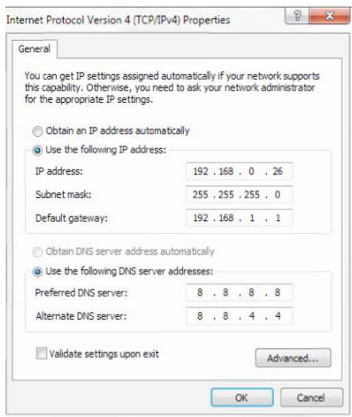

Note: The IP address to be added cannot be same as that of other computers or devices. The existence of this IP address needs to be verified before adding.

Click "Start" and select "Operation" to input cmd as picture below to verify if the network segment has been successfully added.

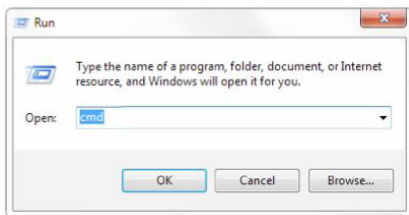

Click "OK" and open the DOS command window, input ping 192.168.5.26 and press the Enter key, it will show the message below: network segment.

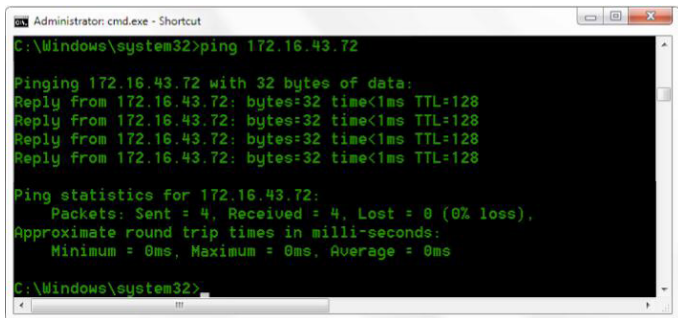

```
Administrator: cmd.exe - Shortcut
C:\Windows\system32>ping 172.16.43.72

Pinging 172.16.43.72 with 32 bytes of data:
Reply from 172.16.43.72: bytes=32 time<1ms TTL=128
Reply from 172.16.43.72: bytes=32 time<1ms TTL=128
Reply from 172.16.43.72: bytes=32 time<1ms TTL=128
Reply from 172.16.43.72: bytes=32 time<1ms TTL=128

Ping statistics for 172.16.43.72:
    Packets: Sent = 4, Received = 4, Lost = 0 (0% loss),
    Approximate round trip times in milli-seconds:
        Minimum = 0ms, Maximum = 0ms, Average = 0ms

C:\Windows\system32>
```

User can also to verify network connection using the steps above once the camera completes self-checking. If IP is default, open DOS command window and input 192.168.5.163, then press the Enter key. It will show the message below: which means the network connection is normal.



```
管理员: C:\Windows\system32\cmd.exe
Microsoft Windows [版本 6.1.7601.1]
版权所有 (c) 2009 Microsoft Corporation。保留所有权利。

C:\Users\Administrator>ping 192.168.5.163

正在 Ping 192.168.5.163 具有 32 字节的数据:
来自 192.168.5.163 的回复: 字节=32 时间<1ms TTL=64
来自 192.168.5.163 的回复: 字节=32 时间<1ms TTL=64
来自 192.168.5.163 的回复: 字节=32 时间<1ms TTL=64
来自 192.168.5.163 的回复: 字节=32 时间<1ms TTL=64

192.168.5.163 的 Ping 统计信息:
    数据包: 已发送 = 4, 已接收 = 4, 丢失 = 0 (0% 丢失),
    往返行程的估计时间(以毫秒为单位):
        最短 = 0ms, 最长 = 1ms, 平均 = 0ms

C:\Users\Administrator>
```

4.2 IE Log In

4.2.1 Web client

1) Web client Log In

Input the IP address 192.168.5.163 of the device in the address field of browser and click Enter button to enter the Web Client logging in page as shown below. User can login as administrator and normal user. If logging as administrator (Default User name/Password: admin), users can preview, playback, configure and cancel in the Web Client; If login in as normal user(Default Username/Password:user1 or user2),users can only preview, playback and cancel, there is no option for configuration.

Note: Web access supported browsers: IE,360 browser and other conventional browsers.

2)Download/Install Plug in

When first using the IE browser to access the web conferencing camera, the login page will appear "Playback plug-in is not installed, please download and install!". Click on this message, download and install MRWebXinstall.exe, according to the prompts. After installing the plug-in, enter user name and password, click and Sign (initial default user name and password: "admin", users can change the user name and password on their own after entering) into the Web client management interface.

4.2.2 Preview

After successful login into the management interface, it enters the video preview interface. In the preview screen, users can control PTZ, zoom, focus, video capture, sound, focus, full screen and set the preset position, run, delete as well as other operations.

You can record the video and save it on an SD Card when SD Card is built in. Videos can be saved on the Computer locally.

1) Login as administrator

User name, password, the default admin.

PTZ control can be carried out, focus, video capture, sound, zoom, full screen, and setting the preset position, running and deleting you can preview,play back and log off.

Note: There areno configuration rights for normal user login.

4.2.3 Playback

1) Playback video files

First,please record,snapshot and save the file when previewing.Click "Playback" to enter recording file and picture files playback page ,and then select the file "Video File" and click Search,search for out the video file, and click Play to play the video file.

2) Playback picture files

First,please record,snapshot and save the file when previewing.Click "Playback" to enter recording file and picture files playback page, then select the file "Image File" and click Search,and search for the video file,and click Play to play the image file.

4.2.4 Configuration

Click Configuration to enter into the device parameters setting page.

These are the following options: Local configuration, audio configuration, video configuration, network configuration, PTZ configuration, internet access configuration, system configuration, for a detailed description please see the following table.

Menu	Explanation
Local configure	Including video preview mode, record video packing time, record video storage route settings etc.
Audio configure	Including audio compressing format, sampling frequency, sampling precision, compressing code rate settings etc.
Video configure	Including video encoding, video parameters, character-overlapping, character size, video output setting etc.
Network configure	Including basic parameters, Ethernet, DNS, wireless network setting, GB28181 etc.
System configure	Including equipment property, system time, user management, version update, Reset, Reboot device settings etc.

1) Local configuration

Video Preview Mode: user can choose real-time priority or fluency priority: The delay will be small when under real time priority mode and fluency will be good when under fluency priority mode. Setting based on user needs (Default value: real time normal (2), real time best (1), fluency normal (3), fluency good (4) and fluency best (5))

Recording packing time(minute): Set recording video packing time (default is 10, range from 1~120 minutes)

Recording/Snapshot file storage route: Set local recording video/snapshot file storage route. (Default D:\MyIPCam\) Click the Save button to make settings effective

2) Audio Configuration

Switch: Choose to enable or disable the audio.

Compressing format: Set audio compressing format and the device will reboot automatically after change (default MP3, PCM, AAC optional)

Sampling frequency: Set sampling frequency and the device will reboot automatically after change (default 44100, 16000, 32000 and 48000 optional)

Sampling precision: Set sampling precision (default 16bits)

Compressing code rate: Set audio compressing code rate (default 64bits, 32, 48, 96, 128bits optional)

Note: Click "SAVE", it will remind the user that Enable has changed. Restart the device to take effect after successfully saving., then please reboot the camera to put the new setting into effect.

4.2.5 Video configuration

1) Video encoding

Code stream:Stream: Different video output mode setting, uses different streams.

(Main stream,secondary stream)

Compression Format: Set the video compression format,save and reboot to take it effect (primary / secondary stream default:H.264,H.265 optional)

Profile: PROFILE MODE SETTING (DEFAULT HP BP MP OPTIONAL)

Video Size: Set video image resolution,save and reboot to put it into effect (main stream default 1920 * 1080 or 1280 * 720 optional; default secondary stream 640 * 320,320 * 180,1280 * 720,1920 * 1080 optional)

Stream Rate control:Set rate control mode,save and reboot to tput it into effect (Primary / secondary stream default variable bit rate,fixed rate is optional).

Image Quality: Set the image quality,image quality can be changed only when rate control is a variable bit rate,(main stream defaulted is better,secondary stream default is not good,there are best,better,-good,bad,worse,worst as for options).

Rate (Kb / s): Set the video bit rate (main stream default 4096Kb / s,64-12288Kb / s optional; secondary stream default 1024Kb /s,64-10240Kb / s optional).

Frame rate (F / S): Set the video frame rate (primary / secondary stream default 25F / S,primary stream 5-60F/S optional,secondary stream 5-30F / S optional) .

Key frame interval: Set the key frame interval (primary / secondary stream default 75F,primary / stream 1-300F optional. secondary stream 1-150F optional).

Stream Name: When streaming via rtsp or rtmp, user can modify stream name. Main Stream(live/av0), sub stream(live/av1) Click the "Save" button to display the "saved successfully" message,then settings take effect.

2) Stream Release

Switch: To turn on/off the main / secondary stream.

Protocol: primary / secondary stream applies RTMP protocol.

Host Port: server port number (default 1935,0-65535 optional)

Host Address: server IP addresses (default 192.168.5.11)

Stream Name: choose a different stream name (live / av0,live / av1 optional).

User: Set the user name.

Password: Set the password.

Click on the "Save" button to display the "Save successful" message,then settings take effect.

Method of obtaining RTSP: rtsp: // device IP address: 554 / live / av0 (av0 main stream; av1 secondary stream)

3, RTP Broadcasting

Main/Sub Stream: On/Off

Protocol: RTP or TS

Address Default: 224.1.2.3. It can be edited.

Port Main Stream Default Port: 4000 Sub Stream Default Port: 4002

Visit: Address comes up after setting. Eg: rtp://224.1.2.3:4000 udp://@224.1.2.3:4000

3) Video Parameters

a,Focus: Focus mode,focus range,focus sensitivity can be set.

Focus Mode: set the focus mode (the default auto,manual optional)

Focus range: set the focus range (the default middle,the upper and lower optional)

Focus Sensitivity: Set the focus sensitivity (default is low,high,medium optional)

b,Exposure: Exposure mode,exposure compensation,back light compensation, anti-flicker,gain limit,wide dynamic,shutter speed,aperture value and brightness can be set.

Exposure Mode: Set the exposure mode (the default automatic,manual,shutter priority,aperture priority,brightness priority optional)

Exposure compensation: Exposure compensation setting is active when it is at auto status (default is off).

Exposure compensation value: Set the exposure compensation value it is,valid when it is set for auto(default 0,-7 to 7 optional).

BLC: Set back light compensation,valid when it is auto status (default is off).

Anti-flicker: Set up anti-flicker mode,valid when status is automatic,aperture or brightness priority (default 50Hz,closed,60Hz optional).

Gain limit: set the gain limits,auto,active when the status is aperture or brightness priority(default 3, 0-15 optional).

Dynamic range: set the dynamic range (default 5,0-8 optional).

Shutter speed: active when the status is manual or shutter-priority (default 1/100 1/25 1/30 1/50 1/60 1/90 1/100 1/120 1/180 1/250 1/350 1/500 1/1000 1/2000 1/3000 1/4000 1/6000 1/10000 optional).

Aperture value: Set the aperture value,active when the status is of manual or aperture-priority(default F1.8,closed, F11,F9.6,F8.0,F6.8,F5.6,F4.8,F4.0,F3.4,F2.8,F2.4,F2.0,F1.8 optional).

Brightness: Set the brightness value,active when it is brightness priority (default 7,0-23 optional).

c,Color:White balance,saturation,color,white balance,sensitivity,color temperature,gain red and blue gain can be set.

White balance modes: Set the white balance mode (the default automatic,3000K,4000K,5000K,6500K,manual,One-push optional).Note: Click the "Correction" button when selecting the One-push white balance mode.

Saturation: Set the saturation (default 80%,60%,70%,80%,90%,100%,110%,120%,130%, optional).

Auto white balance Sensitivity: Sensitivity Auto white balance settings (default is low,high,medium optional).

Chroma: Set the chroma (default 7,0-14 optional).

Color Temperature:set color temperature(Default setting:High,with low,middle for options)

Red Gain: Set the red gain,effective when it is manual (default 255,0-255 optional).

Blue Gain: Sets the Blue gain,effective when it is manual (default 199,0-255 optional).

d,Image:Brightness,contrast,sharpness,black and white mode,the gamma curve,Horizontal Flip and Vertical Flip can be set.

Brightness: Set the brightness (default 6,0-14 optional).

Contrast: set the contrast (default 8,0-14 optional).

Sharpness: Set the sharpness value (default 7, 0-15 optional).

Black and white mode: Set black and white mode (default color, black/white optional).

Gamma: Gamma value setting (default, 0.45, 0.50, 0.52, 0.55 optional).

Flip Horizontal: Set Flip Horizontal (default Off, On optional).

Flip Vertical: Set vertical flip (default Off, On optional).

e, Noise Reduction: 2D noise reduction, 3D noise reduction and dynamic dead pixel correction available.

2D Noise Reduction: Set 2D noise reduction level (default Auto, 1-7 and Off optional).

3D Noise Reduction: Set 3D noise reduction level (default 5, 1-8 and Off optional).

Dynamic dead pixel correction: Set Dynamic dead pixel correction (default Off, 1-8 optional).

Note: Click "Refresh" to make revision of any video parameters of a, b, c, d, e effective.

4) Character-Overlapping

Display date and time: Set whether to display the time and date (default display).

Display Title: Set whether to display the title (default display).

Font Color of Time: Set font color of time and date (default white, black, yellow, red, blue optional).

Font Color of Title: Set font color of title (default white, black, yellow, red, blue optional).

Moving characters: Set the display position of moving date, time and title, click on the "up-, down-, left-, right-" buttons to move the corresponding character's position.

Title Content: Set title content (default CAMERA 1).

Time Content: Set time content (default 1970/01/10 05:36:00)

Click on the "Save" button which is validated by the "Save successful" message.

5) Character Size

Main stream character size: Set the character size of the display, the device will restart automatically after changed and saved (default 24, 24, 16 optional)

Secondary stream character size: Set the character size of the display, the device will restart automatically after changed and saved (default 16, 24, 16 optional)

Click on the "Save" button to display "Parameter saved successfully".

6) Video output

Output Format: Set the video output format (default

1080P60, 1080P50, 1080P30, 1080P25, 1080I60, 1080I50, 720P60, 720P50, 720P30, 720P25, 1080P59.94, 1080I59.94, 1080P29.97, 720P59.94, 720P29.97 optional).

Note: only ST and HD have this item, U3 and U2 do not.

Click on the "Save" button, it will be valid when the display shows "Save successful",

7) USB subtitle

Display subtitles: Check the box (after checking, USB video output is displayed on the screen caption content)

Font color: Default white, black. Yellow, red, blue optional

Subtitle: Users can fill in their own

Ticker: according to user demand, down, left and right to move the display position of subtitles

Note: only U3 and U2 models have this item, ST and HD do not.

4.2.6 Network configuration

1) Network port

Data port: set the data port, the device will restart automatically after being changed (default 3000,0-65535 optional).

Web Port: Set Web port, the device will restart automatically after being changed (default is 80,0-65535 is optional).

Onvif Port: Set Onvif port, the device will restart automatically after being changed (default 2000,0-65535 optional).

Soap Port: Set Soap port (default 1936,0-65535 optional).

RTMP Port: Set RTMP port (default 1935,0-65535 optional).

RTSP Port: Set RTSP port, the device will restart automatically after being changed (default 554,0-65535 optional).

Visca Port: Set Visca port, the device will restart automatically after being changed (default 3001,0-65535 optional).

Click on the "Save" button, it will be valid when it displays "Save successful".

RTMP access: RTMP: // equipment IP address: 1935 / live/av0 (av0 main stream; av1 second stream)

RTMP Access rtmp://equipment IP address: 1935 / live/av0 (av0 main stream; av1 second stream)

2) Ethernet parameters

DHCP: Enable or disable obtain IP can be set. Save changes and reboot the device to put into effect (Default:OFF)

IP Address: Set the IP address, save changes and reboot the device to take effect (default 192.168.5.163).

Note: This IP address is the same as the one used to log into Web page.

Subnet Mask: Set the subnet mask (default 255.255.255.0).

Default Gateway: Set the default gateway (default 0.0.0.0).

Physical Address: Set the physical address (the parameter is read-only but cannot be modified).

Click on the "Save" button, it will be valid when it displays "Save successful". (Note: To prevent IP conflicts When modify).

3) DNS parameters

Preferred DNS server: set the preferred DNS server. (Default 0.0.0.0).

Alternate DNS server: Alternate DNS server settings. (Default 0.0.0.0).

Click on the "Save" button, it will be valid when it displays "Save successful".

4) GB28181

Switch: check whether GB28181 is open

Time Synchronization: you can check whether synchronization time is set.

Stream Type: stream type setting (the default main stream, secondary stream optional)

Sign effective time (in seconds): 3600 Range 5-65535

Heartbeat time (seconds): 60 Range 1-65535

Register ID: 34020000001320000001

Register User name: IPC

Register Password: 12345678

Equipment ownership: Users can add their own

Administrative regions: Users can add their own.

Alarm Zone: Users can add their own

Equipment installation address: Users can add their own

Local SIP Port: 5060 Range 0-65535

GB28181 Server Address: IP address of the computer

Server SIP Port: 5060 Range 0-65535

Server ID: 34020000002000000001

Click on the "Save" button, it will be valid when it displays "Save successful".

4.2.7 System configuration

1) Device Properties

Device Name: Set the device name (default is Camera1,users can add their own).

Device ID: Set the device ID (default 1,Read-Only).

System Language: Set the system language (default Simplified Chinese,English optional). You need to log in again after modifying and saving the settings.

Click on the "Save" button, it will be valid when "Save successful".

2) System Time

Date Format: Set the date format (YYYY-MM-DD default That year - month - day,MM-DD-YYYY , Month - Day -Year,DD-MM-YYYY date - month - year Optional).

Date separator: set the date separator (default '/';':'- Optional).

Time Zone: Set the time zone (default East eight districts,other time zones optional).

Time Type: Set the time types (default 24 hours,optional 12 hours).

Time setting: Set time mode (to choose the computer time synchronization,NTP server time synchronization,or set manually).

Computer Time: Set the computer synchronization.

Update interval: Set the NTP server automatic updated time interval.Valid after setting NTP server synchronization (default one day,2-10 days Optional).

NTP server address or domain name: Set NTP server address or domain name (default time.nits.gov). Valid after setting NTP server synchronization.

NTP Server Port: Sets the NTP server port (default 123).Valid after setting NTP server synchronization. Set the time manually,Effective when set manually.

Click on the "Save" button, it will be valid when "Save successful".

3) User Management

Select users: Set the user type (the default administrator,Common User 1,Common User 2 optional)

User name: set the user name (Select User Administrator default admin; select a common user1 default user1; to select a common users 2 default user2; user can modify their own)

Password: Set a password(Select User Administrator default admin; select a common user1 default user1; to select a common user 2 default user2; user can modify their own).

Password confirmation: Confirm the input passwords are the same or not.

Click on the "Save" button to display the "Save successfully" message.

Note: Please note the case-sensitivity of the user name and password.

If logging in with a common user name and password, one does not have configuration privileges and can only operate preview, playback, and log off.

4) Version upgrade

MCU version V2.0.0.16 2015-12-18

Camera version V2.0.0.16 2015-12-18

Focus version V2.0.0.6 2015-12-11

Users only read the version information above which is consistent with the menu version but cannot modify. Different parts of the machine have different information.

Update file:

Click "Browse ..." installation, to select the upgrade file in the pop-up window.

Click on the "Upgrade" button, the upgrade dialogue will appear. The device will reboot automatically after update successfully.

(Note: make sure the power and network is connected during the process or the upgrade will fail)

Note: After the version upgrade is complete, you need to restore factory defaults; a, through web to restore the factory default configuration; b, through the recovery menu; c, through remote control shortcut * # 6; Choose one of the above three ways. If chose a, the IP accounts, passwords also need to be restored to the default.

5) Restore factory setting

Click on pop-up "Restore Factory Defaults" button and choose "yes" or "no", then the device will restart automatically and restore the factory setting.

6) Reboot

Click on the pop-up "Reboot" button and choose "yes" or "no", then the device will restart automatically.

4.2.8 Logout

Point "Logout" pop-up "Confirmation" dialog; select "Yes" or "No", choose "Yes" to exit the current page and return to the user login interface again.

4.2.9 Wireless network

If the user's equipment has a wireless network module, the "Network Configuration" has a "Wireless Network" configuration page, the specific configuration is as follows:

1 Network settings

Wireless network configuration:

Enable Network Interface: can be checked, to set the following items after checking.

DHCP: can be checked, once checked, if check, it can obtain IP automatically.

IP address: set wireless WIFI IP (default 192.168.1.250, if checked DHCP, IP can assign automatically)

Note: wireless IP address can not be in the same segment with wired IP address.

Subnet Mask: Set the wireless IP subnet mask (default 255.255.255.0)

Default Gateway: Set the wireless IP default gateway (default 192.168.1.1)

SSID: The user can modify their own (the default test)

Encryption: can check, the password can be set after checking.

Password: password can be set, password can be changed if only checked encryption.

Click on the "Save" button to display "Parameter saved successfully" message, set to take effect

Note: SSID and password should be filled in correctly, otherwise, if restarted after only if encryption is checked off, the wireless WiFi connection will not be successful.

2) WiFi hot link

Click on the "search" button to search the WiFi hotspot.

Double-click the dialog box after searching for the user WiFi hotspot, and then input password to connect to WiFi. It is successfully connected once the "successful connect" window is displayed.

3) Wireless WiFi login page

If you did not check the above configuration DHCP (automatically obtain IP), then open the browser, enter the wireless network IP address in the address bar (default 192.168.1.250), press Enter to log construction; if you checked the DHCP, then you obtain IP automatically, just log into the specific router or switch user interface settings to view the allocation of the IP address.

5. SERIAL COMMUNICATION CONTROL

Under common working conditions, the camera can be controlled through the RS232/RS485 interface (VISCA), RS232C serial parameter are as follows:

Baud rate: 2400/4800/9600/115200 bits / sec; Start bit: 1; data bits: 8; Stop bit: 1; Parity: None.

After powering on, the camera first moves left, then back to the middle position. Self-test is finished after the zoom moves to the farthest and then back to the nearest position. If the camera saved the 0 preset before, it will be back in that position after initialization. At this point, the user can control the camera using the serial commands.

5.1 VISCA protocol list

5.1.1 Camera return command

Ack/Completion Message		
	Command packet	Note
ACK	z0 41 FF	Returned when the command is accepted.
Completion	z0 51 FF	Returned when the command has been executed.

z = camera address + 8

Error message		
	Command packet	Note
Syntax Error	z0 60 02 FF	Returned when the command format is different or when a command with illegal command parameters is accepted.
Command Not Executable	z0 61 41 FF	Returned when a command cannot be executed due to current conditions. For example, when commands controlling the focus manually are received during auto focus.

5.1.2 Camera control command

Command	Function	Command packet	Note
AddressSet	Broadcast	88 30 0p FF	p: Address setting
IF_Clear	Broadcast	88 01 00 01 FF	I/F Clear
CommandCancel		8x 21 FF	
CAM_Power	On	8x 01 04 00 02 FF	Power ON/OFF
	Off	8x 01 04 00 03 FF	
CAM_Zoom	Stop	8x 01 04 07 00 FF	
	Tele (Standard)	8x 01 04 07 02 FF	
	Wide (Standard)	8x 01 04 07 03 FF	
	Tele (Variable)	8x 01 04 07 2p FF	p = 0(low) - F(high)
	Wide (Variable)	8x 01 04 07 3p FF	
	Direct	8x 01 04 47 0p 0q 0r 0s FF	pqrs: Zoom Position
CAM_Focus	Stop	8x 01 04 08 00 FF	
	Far (Standard)	8x 01 04 08 02 FF	
	Near(Standard)	8x 01 04 08 03 FF	
	Far(Variable)	8x 01 04 08 2p FF	p = 0(low) - F(high)
	Near (Variable)	8x 01 04 08 3p FF	
	Direct	8x 01 04 48 0p 0q 0r 0s FF	pqrs: Focus Position
	Auto Focus	8x 01 04 38 02 FF	
	One Push Mode	8x 01 04 38 04 FF	
Manual Focus	8x 01 04 38 03 FF		
Cam_Zoom Focus	Direct	8x 01 04 47 0p 0q 0r 0s 0t 0u 0v 0w FF	pqrs: Zoom Position tuwv: Focus Position
CAM_WB	Auto	8x 01 04 35 00 FF	
	3000K	8x 01 04 35 01 FF	
	4000k	8x 01 04 35 02 FF	
	One Push mode	8x 01 04 35 03 FF	
	5000k	8x 01 04 35 04 FF	
	Manual	8x 01 04 35 05 FF	
	6500k	8x 01 04 35 06 FF	
	3500k	8x 01 04 35 07 FF	

Command	Function	Command packet	Note
CAM_WB	4500k	8x 01 04 35 08 FF	
	5500k	8x 01 04 35 09 FF	
	6000k	8x 01 04 35 0A FF	
	7000k	8x 01 04 35 0B FF	
CAM_RFain	Reset	8x 01 04 03 00 FF	Manual Control of R Gain
	Up	8x 01 04 03 02 FF	
	Down	8x 01 04 03 03 FF	
	Direct	8x 01 04 43 00 00 0p 0q FF	pp: R Gain
CAM_Bgain	Reset	8x 01 04 04 00 FF	Manual Control of B Gain
	Up	8x 01 04 04 02 FF	
	Down	8x 01 04 04 03 FF	
	Direct	8x 01 04 44 00 00 0p 0q FF	pp: B Gain
CAM_AE	Full Auto	8x 01 04 39 00 FF	Automatic Exposure mode
	Manual	8x 01 04 39 03 FF	Manual Control mode
	Shutter priority	8x 01 04 39 0A FF	Shutter Priority Automatic Exposure mode
	Iris priority	8x 01 04 39 0B FF	Iris Priority Automatic Exposure mode
	Bright	8x 01 04 39 0D FF	Bright mode
CAM_Shutter	Reset	8x 01 04 0B 00 FF	Iris Setting
	Up	8x 01 04 0B 02 FF	
	Down	8x 01 04 0B 03 FF	
	Direct	8x 01 04 4B 00 00 0p 0q FF	pp: Iris Position
CAM_Gain Limit	Gain Limit	8x 01 04 2C 0p FF	p: Gain Positon
CAM_Bright	Reset	8x 01 04 0D 00 FF	Bright Setting
	Up	8x 01 04 0D 02 FF	
	Down	8x 01 04 0D 03 FF	
	Direct	8x 01 04 4D 00 00 0p 0q FF	pp: Bright Positon
CAM_ExpComp	On	8x 01 04 3E 02 FF	Exposure Compensation ON/OFF
	Off	8x 01 04 3E 03 FF	
	Reset	8x 01 04 0E 00 FF	Exposure Compensation Amount Setting

Command	Function	Command packet	Note
CAM_ExpComp	Up	8x 01 04 0E 02 FF	Exposure Compensation Amount Setting
	Down	8x 01 04 0E 03 FF	
	Direct	8x 01 04 4E 00 00 0p 0q FF	pq: ExpComp Position
CAM_Back Light	On	8x 01 04 33 02 FF	Back Light Compensation
	Off	8x 01 04 33 03 FF	
CAM_WDRStrength	Reset	8x 01 04 21 00 FF	WDR Level Setting
	Up	8x 01 04 21 02 FF	
	Down	8x 01 04 21 03 FF	
	Direct	8x 01 04 51 00 00 00 0p FF	p: WDR Level Position
CAM_NR 2D		8x 01 04 53 0p FF	P=0-7 0:OFF
CAM_NR 3D		8x 01 04 54 0p FF	P=0-8 0:OFF
CAM_Gamma		8x 01 04 5B 0p FF	p = 0 - 4 0: Default 1: 0.47 2: 0.50 3: 0.52 4: 0.55
CAM_Flicker	Off	8x 01 04 23 00 FF	Off
	50Hz	8x 01 04 23 01 FF	50HZ
	60Hz	8x 01 04 23 02 FF	60HZ
CAM_Aperture	Reset	8x 01 04 02 00 FF	Aperture Control
	Up	8x 01 04 02 02 FF	
	Down	8x 01 04 02 03 FF	
	Direct	8x 01 04 42 00 00 0p 0q FF	pq: Aperture Gain
CAM_Memory	Reset	8x 01 04 3F 00 pq FF	pq: Memory Number(=0 to 254) Corresponds to 0 to 9 on the Remote Commander
	Set	8x 01 04 3F 01 pq FF	
	Recall	8x 01 04 3F 02 pq FF	
CAM_LR_Reverse	On	8x 01 04 61 02 FF	Image Flip Horizontal ON/OFF
	Off	8x 01 04 61 03 FF	
CAM_PictureFlip	On	8x 01 04 66 02 FF	Image Flip Vertical ON/OFF
	Off	8x 01 04 66 03 FF	
CAM_ColorSaturation	Direct	8x 01 04 49 00 00 00 0p FF	P=0-7 0:60% 1:70% 2:80% 3:90% 4:100% 5:110% 6:120% 7:130%
CAM_IDWrite		8x 01 04 22 0p 0q 0r 0s FF	pqrs: Camera ID (=0000 to FFFF)

Command	Function	Command packet	Note
CAM_ExpComp	Up	8x 01 04 0E 02 FF	Exposure Compensation Amount Setting
	Down	8x 01 04 0E 03 FF	
	Direct	8x 01 04 4E 00 00 0p 0q FF	pq: ExpComp Position
CAM_Back Light	On	8x 01 04 33 02 FF	Back Light Compensation
	Off	8x 01 04 33 03 FF	
CAM_WDRStrength	Reset	8x 01 04 21 00 FF	WDR Level Setting
	Up	8x 01 04 21 02 FF	
	Down	8x 01 04 21 03 FF	
	Direct	8x 01 04 51 00 00 00 0p FF	p: WDR Level Position
CAM_NR 2D		8x 01 04 53 0p FF	P=0-7 0:OFF
CAM_NR 3D		8x 01 04 54 0p FF	P=0-8 0:OFF
CAM_Gamma		8x 01 04 5B 0p FF	p = 0 - 4 0: Default 1: 0.47 2: 0.50 3: 0.52 4: 0.55
CAM_Flicker	Off	8x 01 04 23 00 FF	Off
	50Hz	8x 01 04 23 01 FF	50HZ
	60Hz	8x 01 04 23 02 FF	60HZ
CAM_Aperture	Reset	8x 01 04 02 00 FF	Aperture Control
	Up	8x 01 04 02 02 FF	
	Down	8x 01 04 02 03 FF	
	Direct	8x 01 04 42 00 00 0p 0q FF	pq: Aperture Gain
CAM_Memory	Reset	8x 01 04 3F 00 pq FF	pq: Memory Number(=0 to 254) Corresponds to 0 to 9 on the Remote Commander
	Set	8x 01 04 3F 01 pq FF	
	Recall	8x 01 04 3F 02 pq FF	
CAM_LR_Reverse	On	8x 01 04 61 02 FF	Image Flip Horizontal ON/OFF
	Off	8x 01 04 61 03 FF	
CAM_PictureFlip	On	8x 01 04 66 02 FF	Image Flip Vertical ON/OFF
	Off	8x 01 04 66 03 FF	
CAM_ColorSaturation	Direct	8x 01 04 49 00 00 00 0p FF	P=0-7 0:50% 1:70% 2:80% 3:90% 4:100% 5:110% 6:120% 7:130%
CAM_IDWrite		8x 01 04 22 0p 0q 0r 0s FF	pqrs: Camera ID (=0000 to FFFF)

Command	Function	Command packet	Note
CAM_IDWrite		8x 01 04 22 0p 0q 0r 0s FF	pqrs: Camera ID (=0000 to FFFF)
SYS_Menu	On	8x 01 04 06 06 02 FF	Turn off the menu screen
	Off	8x 01 04 06 06 03 FF	
IR_Receive	On	8x 01 7D 01 03 00 00 FF	IR(remote commander)/receive message via the VISCA communication ON/OFF
	Off	8x 01 7D 01 13 00 00 FF	
CAM_SettingReset	Reset	8x 01 04 A0 10 FF	Reset Factory Setting
CAM_Brightness	Direct	8x 01 04 A1 00 00 0p 0q FF	pq: Brightness Position
CAM_Contrast	Direct	8x 01 04 A2 00 00 0p 0q FF	pq: Contrast Position
CAM_Flip	Off	8x 01 04 A4 00 FF	Single Command For Video Flip
	Flip-H	8x 01 04 A4 01 FF	
	Flip-V	8x 01 04 A4 02 FF	
	Flip-HV	8x 01 04 A4 03 FF	
CAM_VideoSystem	Set camera video system	8x 01 06 35 00 0p FF	P: 0~E Video format 0:1080P60 8:720P30 1:1080P50 9:720P25 2:1080i60 A 1080P59.94 3:1080i50 B 1080i59.94 4:720P60 C 720P59.94 5:720P50 D 1080P29.97 6:1080P30 E 720P29.97 7:1080P25
Pan_tiltDrive	Up	8x 01 06 01 VV WW 03 01 FF	VV: Pan speed 0x01 (low speed) to 0x18 (high speed) WW: Tilt speed 0x01 (low speed) to 0x14 (high speed) YYYY: Pan Position ZZZZ: Tilt Position
	Down	8x 01 06 01 VV WW 03 02 FF	
	Left	8x 01 06 01 VV WW 01 03 FF	
	Right	8x 01 06 01 VV WW 02 03 FF	
	Up Left	8x 01 06 01 VV WW 02 03 FF	
	Up Right	8x 01 06 01 VV WW 02 01 FF	
	Down Left	8x 01 06 01 VV WW 01 02 FF	
	Down Right	8x 01 06 01 VV WW 02 02 FF	
	Stop	8x 01 06 01 VV WW 03 03 FF	
	Absolute Position	8x 01 06 02 VV WW 0Y 0Y 0Y 0Y 0Z 0Z 0Z 0Z FF	
	Relative Position	8x 01 06 03 VV WW 0Y 0Y 0Y 0Y 0Z 0Z 0Z 0Z FF	

Command	Function	Command packet	Note
Pan_tiltDrive	Home	8x 01 06 04 FF	VV: Pan speed 0x01 (low speed) to 0x18 (high speed) WW: Tilt speed 0x01 (low speed) to 0x14 (high speed) YYYY: Pan Position ZZZZ: Tilt Position
	Reset	8x 01 06 05 FF	
Pan-tiltLimitSet	Set	8x 01 06 07 00 0W 0Y 0Y 0Y 0Y 0Z 0Z 0Z 0Z 0Z FF W:1 UpRight 0: Y:1 UpRight 0:	W:1 UpRight 0:DownLeft YYYY: Pan Limit Position(TBD) ZZZZ: Tilt Limit Position(TBD)
	Clear	8x 01 06 07 01 0W 07 0F 0F 0F 07 0F 0F 0F FF	

5.1.3.Inquiry command

Command	Function	Command packet	Note
CAM_PowerInq	8x 09 04 00 FF	y0 50 02 FF	On
		y0 50 03 FF	Off (Standby)
CAM_ZoomPosInq	8x 09 04 47 FF	y0 50 0p 0q 0r 0s FF	pqrs: Zoom Position
CAM_FocusAF ModelInq	8x 09 04 38 FF	y0 50 02 FF	Auto Focus
		y0 50 03 FF	Manual Focus
		y0 50 04 FF	One Push mode
CAM_FocusPosInq	8x 09 04 48 FF	y0 50 0p 0q 0r 0s FF	pqrs: Focus Position
CAM_WBModelInq	8x 09 04 35 FF	y0 50 00 FF	Auto
		y0 50 01 FF	3000K
		y0 50 02 FF	4000K
		y0 50 03 FF	One Push Mode
		y0 50 04 FF	5000K
		y0 50 05 FF	Manual
		y0 50 00 FF	6500K
		y0 50 06 FF	6500K
		y0 50 07 FF	3500K
		y0 50 08 FF	4500K
		y0 50 09 FF	5500K
y0 50 0A FF	6000K		

Command	Function	Command packet	Note
CAM_WBModelnq		y0 50 0B FF	7000K
CAM_RGainInq	8x 09 04 43 FF	y0 50 00 00 0p 0q FF	pq: R Gain
CAM_BGainInq	8x 09 04 44 FF	y0 50 00 00 0p 0q FF	pq: B Gain
CAM_AEModelnq	8x 09 04 39 FF	y0 50 00 FF	Full Auto
		y0 50 03 FF	Manual
		y0 50 0A FF	Shutter priority
		y0 50 0B FF	Iris priority
		y0 50 0D FF	Bright
CAM_ShutterPosInq	8x 09 04 4A FF	y0 50 00 00 0p 0q FF	pq: Shutter Position
CAM_IrisPosInq	8x 09 04 4B FF	y0 50 00 00 0p 0q FF	pq: Iris Position
CAM_Gain LimitInq	8x 09 04 2C FF	y0 50 0p FF	p: Gain Positon
CAM_BrightPosInq	8x 09 04 4D FF	y0 50 00 00 0p 0q FF	pq: Bright Position
CAM_ExpCompModelnq	8x 09 04 3E FF	y0 50 02 FF	On
		y0 50 03 FF	Off
CAM_ExpCompPosInq	8x 09 04 4E FF	y0 50 00 00 0p 0q FF	pq: ExpComp Position
CAM_BacklightModelnq	8x 09 04 33 FF	y0 50 02 FF	On
		y0 50 03 FF	Off
CAM_WDRStrengthInq	8x 09 04 51 FF	y0 50 00 00 00 0p FF	p: WDR Strength
CAM_NRLevel(2D)Inq	8x 09 04 53 FF	y0 50 0p FF	P: 2DNRLLevel
CAM_NRLevel(3D)Inq	8x 09 04 54 FF	y0 50 0p FF	P:3D NRLevel
CAM_FlickerModelnq	8x 09 04 55 FF	y0 50 0p FF	p: Flicker Settings(0: OFF, 1: 50Hz, 2:60Hz)
CAM_ApertureInq	8x 09 04 42 FF	y0 50 00 00 0p 0q FF	pq: Aperture Gain
CAM_PictureEffectModelnq	8x 09 04 63 FF	y0 50 00 FF	B&W
		y0 50 04 FF	p: Memory number last operated
SYS_MenuModelnq	8x 09 06 06 FF	y0 50 02 FF	On
		y0 50 03 FF	Off

Command	Function	Command packet	Note
CAM_LR_ReverseInq	8x 09 04 61 FF	y0 50 02 FF	On
		y0 50 03 FF	Off
CAM_PictureFlipInq	8x 09 04 66 FF	y0 50 02 FF	On
		y0 50 03 FF	Off
CAM_ColorSaturationInq	8x 09 04 49 FF	y0 50 00 00 00 0p FF	p: Color Gain setting 0h (60%) to Eh (130%)
CAM_IDInq	8x 09 04 22 FF	y0 50 0p FF	p: Gamma ID
IR_ReceiveInq	8x 09 06 08 FF	y0 50 02 FF	On
		y0 50 03 FF	Off
IR_ReceiveReturn		y0 07 7D 01 04 00 FF	Power ON/OFF
		y0 07 7D 01 04 07 FF	Zoom tele/wide
		y0 07 7D 01 04 38 FF	AF ON/OFF
		y0 07 7D 01 04 33 FF	Camera _Backlight
		y0 07 7D 01 04 3F FF	Camera Memory
		y0 07 7D 01 06 01 FF	Pan_titleDriver
CAM_BrightnessInq	8x 09 04 A1 FF	y0 50 00 00 0p 0q FF	pq: Brightness Position
CAM_ContrastInq	8x 09 04 A2 FF	y0 50 00 00 0p 0q FF	pq: Contrast Position
CAM_FlipInq	8x 09 04 A4 FF	y0 50 00 FF	Off
		y0 50 01 FF	Flip-H
		y0 50 02 FF	Flip-V
		y0 50 03 FF	Flip-HV
CAM_GammaInq	8x 09 04 5B FF	y0 50 0p FF	p: Gamma setting
CAM_VersionInq	8x 09 00 02 FF	y0 50 ab cd mn pq rs tu vw FF	ab cd : vender ID (0220) mn pq : model ID ST (0950) U3 3950 rs tu : ARM Version vw : reserve

Command	Function	Command packet	Note
VideoSystemInq	8x 09 06 23 FF	y0 50 0p FF	P: 0-E Video format 0:1080P60 8:720P30 1:1080P50 9:720P25 2:1080i60 A 1080P59.94 3:1080i50 B 1080i59.94 4:720P60 C 720P59.94 5:720P50 D 1080P29.97 6:1080P30 720P29.97 7:1080P25 E
Pan-tiltMaxSpeed-Inq	8x 09 06 11 FF	y0 50 ww zz FF	ww: Pan Max Speed zz: Tilt Max Speed
Pan-tiltPosInq	8x 09 06 12 FF	y0 50 0w 0w 0w 0w 0z 0z 0z 0z FF	www: Pan Position zzzz: Tilt Position

Note: [X] in the above table indicates the camera address to be operated, $y = x + 8$.

5.2, Pelco-D protocol command list

Function	Byte1	Byte2	Byte3	Byte4	Byte5	Byte6	Byte7	
Up	0xFF	Address	0x00	0x08	Pan Speed	Tilt Speed	SUM	
Down				0x10				
Left				0x04				
Right				0x02				
Up Left				0x0C				
Up Right				0x0A				
Down Right				0x14				
Zoom In				0x12				
Zoom Out			0x20	0x00	0X00			
Focus Far			0x40					
Focus Near			0x01			0x80		
Set Preset			0x00			0x00		Preset ID
Clear Preset			0x00			0x03		

Function	Byte1	Byte2	Byte3	Byte4	Byte5	Byte6	Byte7
Call Preset	0xFF	Address	0x00	0x07	0x00	Preset ID	SUM
Query Pan Position				0x51	0x00	0x00	
Query Pan Position Response				0x59	Value High Byte	Value Low Byte	
Query Tilt Position				0x53	0x00	0x00	
Query Tilt Position Response				0x5B	Value High Byte	Value Low Byte	
Query Zoom Position				0x55	0x00	0x00	
Query Zoom Position				0x5D	Value High	Value Low	
Response					Byte	Byte	

5.3 Pelco-P protocol command list

Function	Byte1	Byte2	Byte3	Byte4	Byte5	Byte6	Byte7	Byte8
Up	0xA0	Address	0x00	0x08	Pan Speed	Tilt Speed	0xAF	XOR
Down				0x10				
Left				0x04				
Right				0x02				
Up Left				0x0C				
Up Right				0x0A				
Down Left				0x14				
Down Right				0x12				
Zoom In				0x20				
Zoom Out			0x40					
Focus Far			0x01	0x00				
Focus Near			0x00					
Set Preset			0x03					
Clear Preset			0x05					
Call Preset			0x07					
Query Pan Position	0x51							
Query Pan Position Response	0x59	Value High Byte	Value Low Byte					

Function	Byte1	Byte2	Byte3	Byte4	Byte5	Byte6	Byte7	Byte8
Query Tilt Position	0xA0	Address	0x00	0x53	0x00	0x00	0xAF	XOR
Query Tilt Position Response				0x5B	Value High Byte	Value Low Byte		
Query Zoom Position				0x55	0x00	0x00		
Query Zoom Position Response				0x5D	Value High Byte	Value Low Byte		

6. CAMERA MAINTENANCE AND TROUBLESHOOTING

6.1 Camera Maintenance

- 1) If camera is not used for long time, please turn off power adapter switch and AC plug.
- 2) Use soft cloth or tissue to clean the camera cover.
- 3) Use soft cloth to clean the lens use a neutral cleanser if badly smeared Do not use a strong or corrosive cleanser to avoid damage.

6.2 Troubleshooting

1) No video output

- a, Check whether the camera power supply is connected, the voltage is normal, the power indicator is lit.
- b, Whether the machine could complete self-inspection after restarting.
- c, Check whether the bottom of the DIP switch in the normal operating mode (see Table 2.2 and Table 2.3)
- d, Check whether the video output cable or video display is normal

2) Occasionally no image

- a, Check whether the video output cable or video display is normal

3) Image dithering when zoomed-in or zoomed-out

- a, Check whether the camera installation position is solid
- b, Whether there is shaking machine or objects around the camera

4) Remote control does not work

- a, Remote control address is set to 1 (if the machine is set back to the factory defaults, remote control addresses need to be back to 1 too)
- b Check whether the battery installed in the remote control is low.
- c, Check that the camera working mode is the normal operating mode. (see Table 2.2 and Table 2.3)
- d, Check whether the menu is closed camera control through remote control only available after exiting the menu If video input is from LAN the menu will not be displayed, the menu will automatically exit 30 seconds later, after which it can be controlled by remote control.

5) Serial port does not work

- Check whether the camera serial device protocol, baud rate, and address is consistent.
- Check whether the control cable is connected properly
- Check whether the camera working mode is the normal operating mode (see Table 2.2 and Table 2.3)

6) Cannot log in to web pages

- Check whether the camera is showing normally.
- Check whether the network cable is connected properly(Ethernet port yellow light flashes to indicate normal network cable connection)
- Check whether your computer has added the segment, and that the segment is consistent with the IP address of the camera.
- Click "Start" and select "Run" and then type "cmd" in the computer;Click "OK" then turn on a DOS command window to enter ping 192.168.5.163. Press the Enter key for the following message to appear. Description network connection is normal.

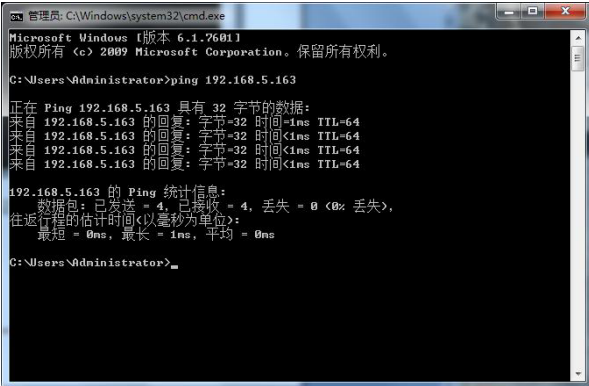

```
管理员: C:\Windows\system32\cmd.exe
Microsoft Windows [版本 6.1.7601]
版权所有 (c) 2009 Microsoft Corporation。保留所有权利。

C:\Users\Administrator>ping 192.168.5.163

正在 Ping 192.168.5.163 具有 32 字节的数据:
来自 192.168.5.163 的回复: 字节=32 时间<1ms TTL=64
来自 192.168.5.163 的回复: 字节=32 时间<1ms TTL=64
来自 192.168.5.163 的回复: 字节=32 时间<1ms TTL=64
来自 192.168.5.163 的回复: 字节=32 时间<1ms TTL=64

192.168.5.163 的 Ping 统计信息:
    数据包: 已发送 = 4, 已接收 = 4, 丢失 = 0 (0% 丢失),
    往返行程的估计时间(以毫秒为单位):
        最短 = 0ms, 最长 = 1ms, 平均 = 0ms

C:\Users\Administrator>
```

PRODUCT DISPOSAL

Safety

For your own safety, this product should only be used with CE and RoHS approved equipment. Using this product with non-approved equipment would void the warranty.

Disposal of your product

Municipal waste stream. Old appliances must be collected separately in order to optimise the recovery and recycling of the materials to reduce the impact on human health and the environment. The crossed out "wheeled bin" symbol on the product reminds you of your obligation that when you dispose of the appliance, it must be separately collected. Consumers should contact their local authority or retailer for information concerning the correct disposal of their old appliance.

Copyright Notice:

All the contents of this manual and the copyright ownership belong to our company. Without the approval of the Company, no one can imitate, copy, reproduce or translate arbitrarily. This manual contains no guarantee, standpoint expression or other implications in any form. Specifications and information of this manual mentioned are solely for informational purposes information is for reference only and subject to change without notice.

All rights reserved. No reproducing is allowed without acknowledgement.

Declaration of conformity:

This product is in conformity with the relevant EU harmonisation legislation.

